

RADIO RETAILING

25 CENTS PER COPY

MCGRAW-HILL PUBLISHING CO.



In this issue . . .

Editor Rost Radios Report on British
TELEVISION RETAILING

November, 1937

ARE YOU AN OLD TIMER?



DO YOU REMEMBER . . .

WHEN

Chicago broadcasting stations were silent Monday nights so that listeners could hear D.X.?

WHEN

Superheterodynes used a 30 K.C. I.F. and had a filament rheostat for each tube?

WHEN

Gassy detector tubes were preferred because they were more sensitive, and over 22½ volts of "B" battery would make them turn blue?

If you do, you will remember that then, as now, Yaxley Precision Radio Products were preferred by discriminating radio men. Yaxley has always led the march of radio progress by providing dependable easy-to-use radio apparatus.

From the Yaxley Air Cooled Rheostats never equalled by any other manufacturer which controlled the tiny outputs of early battery tubes to the modern Yaxley SILENT Volume Control which smoothly controls the giant output of beam power tubes, that which was once a distinct company and is now the Yaxley Manufacturing Division of P. R. Mallory & Co., Inc., presents a story of constant research and constant progress to produce the finest products of modern engineering.

On the basis of past experience and *present performance* leading radio service men depend on Mallory-Yaxley Precision Radio Products. They demand the best . . .

and they get the best in Mallory Replacement Condensers and Vibrators. They demand the best . . . and they get the best in Yaxley Volume Controls.

So—if you're an *old timer*, or a *newcomer*, in the radio servicing field you'll find it to your advantage to advance your interests with Mallory-Yaxley Precision Radio Replacement Parts. After all, they cost no more—and the longer you use them the more readily you'll agree that they actually *cost less in the long run*.



ONE Book Gives ALL the Right "Dope" on Over 12,000 Different Radios

You'll find the Mallory-Yaxley Radio Service Encyclopedia the biggest help a serviceman ever had. Ask your Mallory-Yaxley distributor about a copy *now!*



MALLORY CONDENSERS • YAXLEY VOLUME CONTROLS • MALLORY VIBRATORS

Use
P. R. MALLORY & CO., Inc.
MALLORY
REPLACEMENT
CONDENSERS . . . VIBRATORS

P. R. MALLORY & CO., Inc.
INDIANAPOLIS INDIANA
Cable Address—PELMALLO

Use
YAXLEY
REPLACEMENT
VOLUME CONTROLS

RADIO RETAILING

NOVEMBER, 1937

O. FRED. ROST Editor
 W. MacDONALD Managing Editor
 C. A. NUEBLING Technical Editor
 T. H. PURINTON Assistant Editor
 HARRY PHILLIPS Art Director

•
 Tom Blackburn George Tenney
 Chicago San Francisco
 H. S. Knowlton
 Boston

•
 HOWARD EHRLICH
 Executive Vice-President

H. W. MATEER
 Manager

RADIO MONTH	11
PHOTOSHORTS	13
PROBLEM IN DECORATION By Mary Davis Gillies	16
RADIO COMES TO KENTUCKY HILLFOLK. By George Carr Ganter	20
GETTING STARTED WITH RECORDS By Richard Gilbert	22
TELEVISION RETAILING By O. Fred. Rost	23
SHOW BUSINESS IT NEEDS SOUND By Tom F. Blackburn	28
WHY TERMS HAVE BEEN SHORTENED By T. O. McDavid	32
RECIPE FOR SELLING REFRIGERATION By Laurence Wray	36
HOLIDAY WINDOW By I. L. Cochrane	41
NEW ELECTRICAL APPLIANCES	42
HANDS ACROSS THE GRIDIRON	47
PREVIEW OF NEW RADIO MERCHANDISE	48
FIGURES	59
NOVEMBER NEWS	61
TECHNICAL TOPICS	79
SOUND INSTALLATION METHODS By J. R. Poppele	80
SOUND INSTALLATION CHART	83
SERVICING PHONO-COMBINATIONS By H. D. Hooton	85
RADIO CIRCUITS	88
SHOP SHORTCUTS	90
TRICKS OF THE TRADE	94
LETTERS	100

McGraw-Hill Publishing Company, Inc.

Publication Office
 99-129 North Broadway, Albany, N. Y.
 Editorial and Executive Offices
 330 West 42nd Street, New York, N. Y.

Cable Address: MCGRAWHILL, New York
 Member A.B.P. Member A.B.C.

James H. McGraw, Jr. President
 Howard Ehrlich Executive Vice-President
 James H. McGraw Honorary Chairman
 B. R. Putnam Treasurer
 D. C. McGraw Secretary
 A. W. Morrison Circulation Manager

RADIO RETAILING, November, 1937, Vol. 22, No. 11. Published monthly, price 25c copy. Subscription rates—United States and possessions, Canada, Mexico and Central American countries \$1. All other countries \$2 a year or eight shillings. Printed in U. S. A. Entered as Second Class Matter, September 8, 1936, at Post Office, Albany, N. Y., under the Act of March 3, 1879. Cable address "McGrawhill, New York." Member of A.B.P. Member of A.B.C. Copyright 1937 by McGraw-Hill Publishing Co., Inc., 330 West 42d Street, New York, N. Y.

Branch Offices: 520 North Michigan Ave., Chicago; 883 Mission St., San Francisco; Aldwych House, Aldwych, London, W.C. 2; Washington; Philadelphia; Cleveland; Detroit; St. Louis; Boston; Atlanta, Ga.

SALES STATIC . . . "IS THAT ALL? I COULD HAVE FIXED THAT MYSELF"



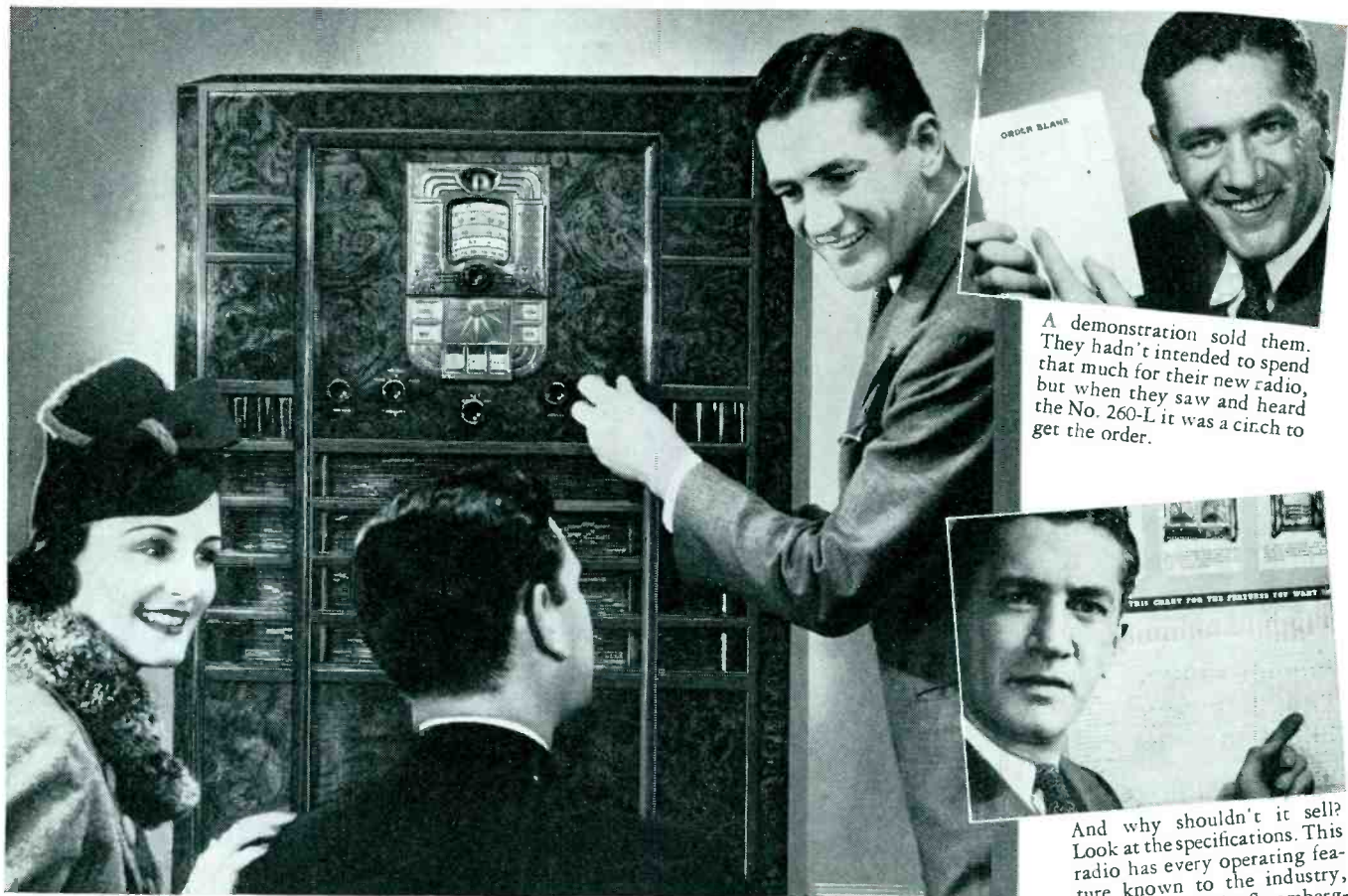

A demonstration sold them. They hadn't intended to spend that much for their new radio, but when they saw and heard the No. 260-L it was a cinch to get the order.

And why shouldn't it sell? Look at the specifications. This radio has every operating feature known to the industry, plus many exclusive Stromberg-Carlson refinements.

Presenting the
NEW No. 260-L

Here, without doubt is the most superb radio which ever has been produced. An owner can proudly and truthfully say: "I have a radio whose performance is unmatched." The mighty volume from its 30 watts of power will fill the spacious rooms of the largest house; yet at fireside volume its glorious perfection of tone remains unchanged.

Some of its important features are: Acoustical Labyrinth arranged for TWO Carpinchce leather speakers; FIVE TUNING RANGES, including ultra short wave, 22000 to 60000 Kc; FLASH TUNING, Stromberg-Carlson's new method of automatic tuning where the call letters of the station instantly light up; the new FORTIFIED CHASSIS, most important structural advance in chassis design since "total shielding"; CLASS A AMPLIFICATION; SIXTEEN tubes.

The hurl walnut cabinet is beautiful beyond words; in keeping with the radio's incomparable performance. People who want fine things—and there are many of them now—will want the No. 260-L. Its price is \$360. (Eastern). Your profit on every sale is an item of importance.

STROMBERG-CARLSON TELEPHONE MFG. CO., ROCHESTER, N. Y.

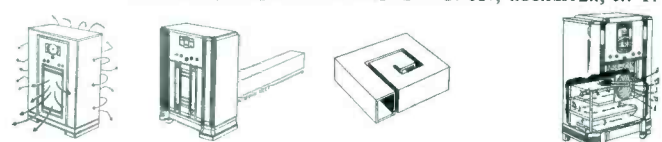

THE TROUBLE—Empty cabinet space in back of the speaker causes "boom" and distorts the pure tone from front of speaker.

THE THEORY—A long tube of sound absorbent material would absorb unwanted sound and reinforce bass tones.

THE THEORY MADE PRACTICAL—Such a tube is out of the question. So Stromberg-Carlson folded it into a Labyrinth.

THE PATENTED ACOUSTICAL LABYRINTH—How the Labyrinth is used in one of the new Stromberg-Carlsons is shown just above. It is the necessary baffle wrapped up, folded over and placed within the troublesome space in the cabinet. Patents have been granted in the United States and Canada.

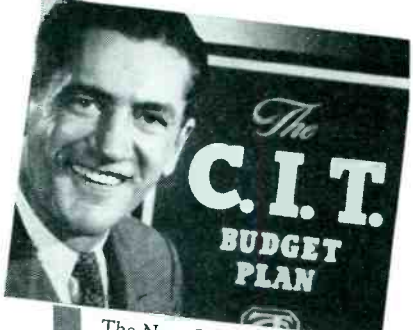

The New C. I. T. Budget Plan makes it easy for customers to buy and pay for such a radio. The Limited Recourse feature of this plan appeals to me too—I'm completely off the paper after four payments.



The No. 260-L is the radio for me. Its superiority is easily demonstrated. Every sale means a worth-while profit, and every person who buys becomes a booster.

There Is Nothing Finer than a
Stromberg-Carlson

SELL *More* AIR CONDITIONING FOR *Less* MONEY

Koolroom

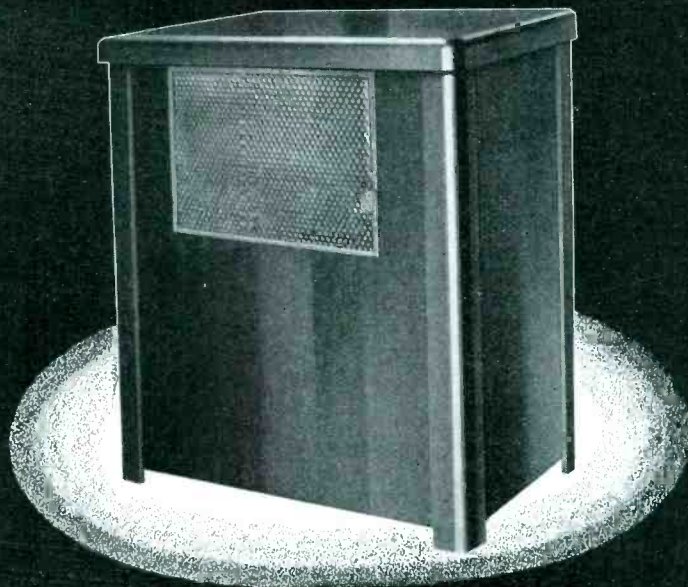

AN INNOVATION IN ROOM COOLERS!

● Some dealer in your community is going to make big money selling KOOLROOM air conditioners to a heretofore untouched market. For as low as \$175, he will offer a full sized unit of unequalled beauty that not only delivers greater cooling performance, but is priced at least \$150 under competition! His sales will probably exceed those of all his competitive dealers combined. And that's only *half* the story. KOOLROOM dealers are getting the biggest discounts being offered in the air conditioning field today. Maybe YOU are the man we want! If we give you the most profitable franchise in air conditioning history, will you turn it into dollars for yourself? Can you beat all competition if you have a unit that surpasses them all—for price, performance, beauty?

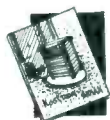

Tear out this section of ad, clip it to your letterhead and mail it TODAY! Get all the facts on KOOLROOM—the most valuable dealership in air conditioning!

Advertised prices are based f.o.b. factory and are subject to change without notice.

MODEL 33A-WS (Portable). Circulates 200 cubic feet of conditioned air per minute. Capacity—4000 B.T.U. per hour. Equal to melting 600 lbs. ice per day. 1/3 H.P. Motor. **\$175**

MODEL 33-W. Circulates 225 cubic feet of conditioned air per minute. Capacity—4,500 B.T.U. per hour. Equal to melting 660 lbs. ice per day. 1/3 H.P. Motor. **\$250**

MODEL 50-W. Circulates 329 cubic feet of conditioned air per minute. Capacity 6,925 B.T.U. per hour. Equal to melting 1100 lbs. ice per day. 1/2 H.P. Motor. **\$350**

MODEL 100-W. Circulates 450 cubic feet of conditioned air per minute. Capacity—14,400 B.T.U. per hour. Equal to melting 2,400 lbs. ice per day. One H.P. Motor. **\$450**

MODEL 150-W. Circulates 600 cubic feet of conditioned air per minute. Capacity—19,000 B.T.U. per hour. Equal to melting 3,100 lbs. ice per day. 1 1/2 H.P. Motor. **\$550**

KOOLROOM • DIVISION OF INDIAN PRODUCTS CORP., 2441 S. MICHIGAN AVE., CABLE "TRAILCO", CHICAGO, U. S. A.

Plus Powered. It Cools. Dehumidifies. Ventilates. Cleans. Circulates



**MAGIC KEY
OF RCA**

To the Radio Merchants of America:

The perfection of the newest radio sets—in fidelity, tone quality, selectivity, mechanical convenience, and beauty of appearance—has been stressed by every radio manufacturer. The improvement over the sets of only a few years ago is so great as to be almost unbelievable.

Yet, when we describe the excellence of the receiver we tell only half the story. For a radio can be only as good as the program. The realization, therefore, that the approaching winter season offers an incomparable selection of radio programs should double the sales appeal of every new set. Never before, in all history, has man had at his fingertips the gift of so many priceless treasures of music, education, drama, comedy, sports and news. These and more are made available to the public through the world's most famous conductors, musicians, artists, actors, and public speakers. The purchaser of a modern radio set really obtains a front-row season ticket to the greatest show ever produced by mankind.

No individual on earth has the wealth to buy, or the power to command, what the radio gives free to the humblest set-owner.

David Sarnoff
PRESIDENT
RADIO CORPORATION OF AMERICA



**WORLD NEWS...
WHILE IT HAPPENS**



**NATIONAL
FARM AND
HOME HOUR**



ARTURO TOSCANINI



NBC SYMPHONY ORCHESTRA



METROPOLITAN OPERA



**AMERICA'S
TOWN MEETING
OF THE AIR**



RADIO CITY, N. Y.

DRAMA



INA GLAIRE



**Pulling
Power**

**Sell Sylvania's! It pays — not only in actual tube profit,
but by pulling future jobs your way, too!**

Here's how Sylvania's dependability can add new profits to your business:

A customer calls you in to service his radio. You find he needs a new set of tubes. Okay, you install the tubes, and that's that.

But wait a minute! That's *not* that . . . not if you install Sylvania's! That customer will be impressed by the fine job you did on his set—by the finer performance it gives. And, as hour after hour of faithful service is completed by these

Sylvania tubes, he's going to say something like this: "Mm-m. Swell buy I got on those tubes. That guy must know his business. Guess I'll call him up *every* time!"

And *that's* that! The next time he phones for service, *you* will be on the other end of the wire—all because you have proven yourself a dependable dealer by selling him dependable tubes.

Sell Sylvania tubes. Put Sylvania's pulling power to work for you.

S Y L V A N I A

SET - TESTED RADIO TUBES

BELMONT Leads Again with the **NEW BEL-MONITOR**

ANY SET OWNER
CAN ADJUST THE
BEL-MONITOR
FOR NEW STATIONS
WITHOUT TOOLS

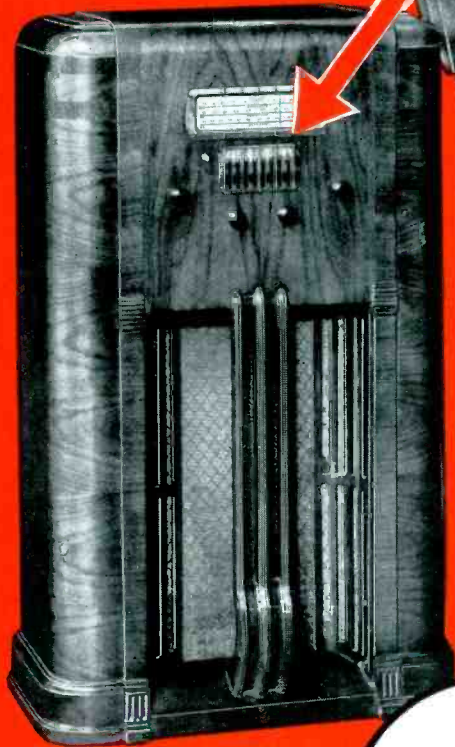

**INSTANT
STATION
SELECTOR**

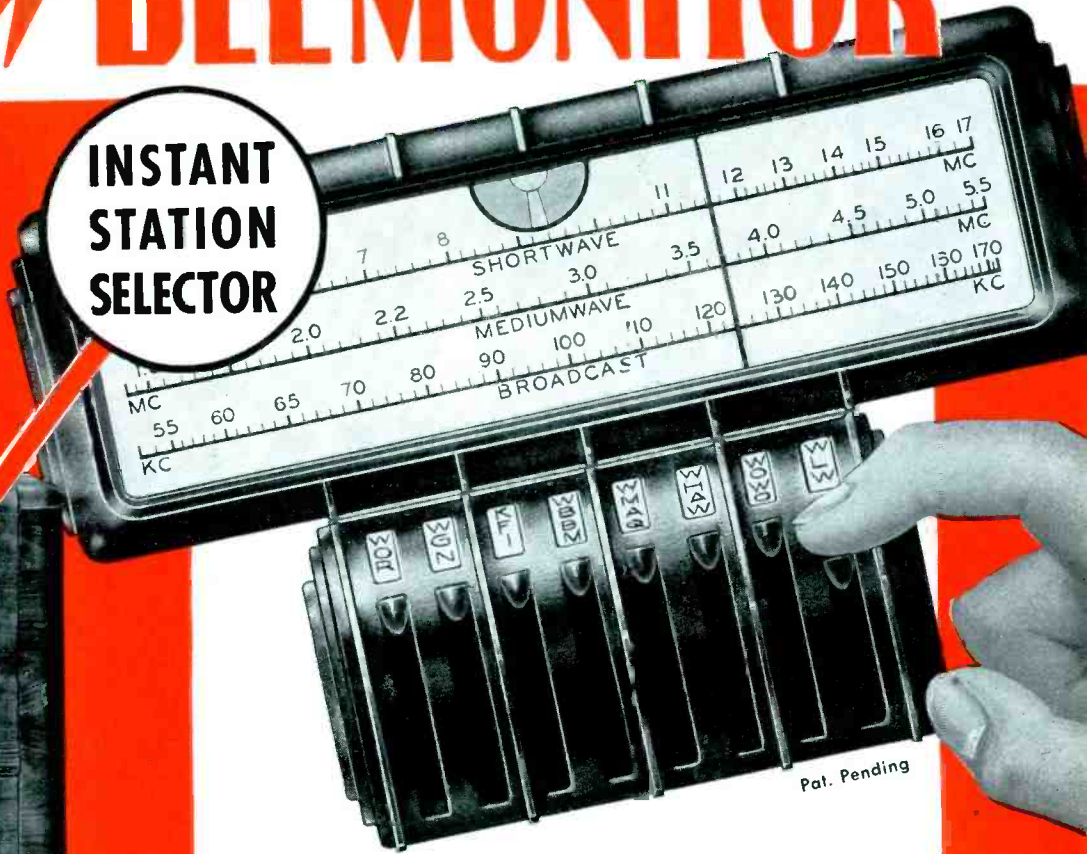

**NOISELESS
FOOL-PROOF**

The BEL-MONITOR 8-Station Selector is now available on two Belmont console, J-band, all-wave a-c superheterodyne high-fidelity receivers—Model 1175 (illustrated above) with 11 tubes and Model 860 (not shown) with 8 tubes. Printed station call letter slips included with each receiver.

The BEL-MONITOR 6-Station Selector is standard equipment on the Belmont table Model 582 (illustrated at right) 5-tube, 2-band a-c superheterodyne receiver. All Belmont sets are licensed under R.C.A. and Hazeltine patents.

Belmont receivers have again "scooped" the radio world with the new BEL-MONITOR Instant Station Selector! It is noiseless and fool-proof. Just press a BEL-MONITOR key and—presto—your station is tuned to split-hair accuracy. The action is instantaneous because the BEL-MONITOR does not follow a fixed sequence of stations—it rotates automatically, forward or backward, through the shortest arc.

BEL-MONITOR settings can be changed without tools. Changeover switches are eliminated and regular tuning with knobs is always available. Write for dealer story today.

BELMONT RADIO CORPORATION
CHICAGO, ILL.

General Offices—1257 Fullerton Ave.
Cable Address—Belrad



THERE'S ONLY ONE "B" BATTERY THAT'S PUNCTURE-PROOF

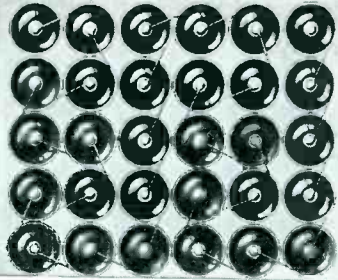

Waste space between the cells accounts for 25 per cent of the cubic contents of the old-fashioned round-cell "B" battery.

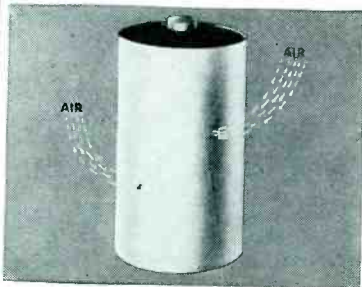

Current is made by electrolyte eating the zinc, which gets thinner and thinner, then perforates...air filters in, the cell dries out, dies.

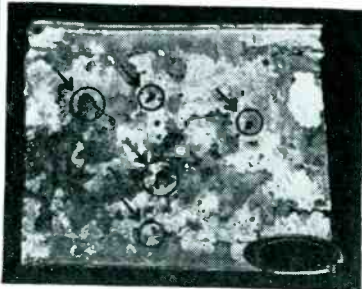

Five tiny "pin-holes" ended the life of this cell, wasting all this good zinc.

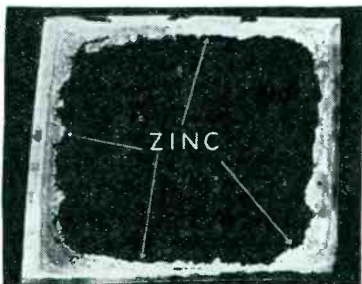

See how little zinc is left in an exhausted "Layerbilt" cell. All the power-making zinc is used up, except for the extreme edge, because *no air gets in*.

"Pin-Holes" Kill old fashioned batteries before their time... You want the modern "B" battery that gives you "everything it's got"!

Sudden death comes to old-fashioned round cell "B" batteries when the zinc cans begin to perforate (which is long before the available current-making zinc is used up). With the first pin-hole perforations, air is admitted to the cell; as it dries out *it dies out*.

But the newer, better "Eveready" "Layerbilt" "B" batteries give longer life than "B" batteries of comparable size ever gave before. This is because of the exclusive *flat-layer construction*, which means power-making zinc is *completely used up* except for a narrow strip along each edge. Air cannot filter in to dry out flat "Layerbilt" cells, so perforation has no effect upon performance. As a further factor of added value, "Layerbilt" "B" batteries are *all-battery*, completely eliminating the 25 per cent of waste-space between the cells of old-fashioned round-cell batteries.

No wonder "Eveready" "Layerbilt" "B" batteries give more service per dollar of cost. When you explain "Layerbilt" construction, your customers will prefer the "B" battery that's *puncture-proof*.

"EVEREADY" TRADE-MARKS "LAYERBILT" "B" BATTERIES



NATIONAL CARBON COMPANY, INC.

GENERAL OFFICES: New York, N. Y. BRANCHES: Chicago, San Francisco

Unit of Union Carbide and Carbon Corporation

The words "Eveready" and "Layerbilt" are trade-marks of National Carbon Co., Inc.



PIONEERS IN THE DEVELOPMENT OF

AUTO-RADIO TUBES

RAYTHEON pioneered the first outstanding tube developments that made home-like reception in auto-radios possible! Since then, Raytheon auto set tubes have been noted for their maximum life under adverse conditions — for their noiseless reception under extreme sensitivity! Raytheons, too, are especially designed and constructed for maximum life over the wide range of voltages in an automobile battery—to work efficiently in close proximity to each other—to withstand the jarring and pounding received on the roughest of roads.

It is almost impossible to find a modern auto-radio not using the latest Raytheon development—the OZ4 rectifier! This fact is a universal tribute to Raytheon engineering. These are the reasons why more auto-radio manufacturers use Raytheon than any other tube —and why almost all servicemen use them as replacements.

RAYTHEON

445 Lake Shore Drive, Chicago, Ill.
55 Chapel Street, Newton, Mass.
415 Peachtree Street, N. E., Atlanta, Ga.

420 Lexington Ave., New York, N. Y.
555 Howard St., San Francisco, Cal.

FOR BETTER RECEPTION

Let me help you

SELL

RADIOS

**TO MILLIONS
OF MY FRIENDS**

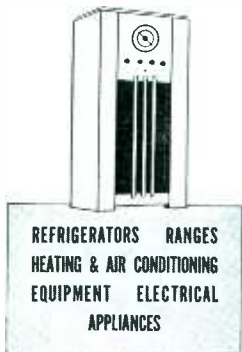

A good many million families in this country are friends of mine.

I have helped them acquire automobiles, refrigerators, heating equipment, washing machines, and many electrical appliances.

Thousands of dealers profited by my assistance in making these sales. You can profit by it, too.

When these same millions and other families come to buy radios, they're going to think of me. If they find me working for you, you're going to find it easier to sell them.

Why? Because they know that the charge for my financing is fair . . . because my collection service has been courteous and considerate. I have their good-will. I know how to hold it for the dealers I work with.

I protect my dealers in other ways, too. I give them a smooth, non-irritating, thoroughly efficient credit investigating service. Since I'm a specialist in consumer credit I can usually spot those risks that might cause trouble and a loss of profit. I make prompt remittances, keep collections regular.

I'm the local manager of a Commercial Credit office in your territory. I can do a lot to help you. Let's talk it over.

COMMERCIAL CREDIT COMPANY

COMMERCIAL BANKERS • HEADQUARTERS BALTIMORE
CONSOLIDATED CAPITAL AND SURPLUS \$65,000,000



SERVING MANUFACTURERS, DISTRIBUTORS AND DEALERS THROUGH 193 OFFICES IN THE UNITED STATES AND CANADA

The RADIO MONTH

Stand Pat Strong manufacturers are not getting jittery because the stock market has taken a few dips and retail set sales showed more than seasonal declines during September and in early October. Carefully analyzed, set sales dropped only in certain territories while in others they bounced upward with the arrival of cold weather, crop money, pay increases, dividend checks and what not.

Seasoned sales managers merely are taking those spotty declines as a warning that this fall and winter the battle for sales will be fiercer than usual and they are strengthening their promotional effort, working closer with dealers and fighting harder for good dealers.

Actually there has been little let-up in the flow of money out of which consumers buy radio sets and other goods. Crops are good. Prices are high. Dividends paid by many concerns are at record levels. Payrolls have not declined and wage rates are still rising.

Its just a matter of improving the sales technique that brings the consumer's dollars jingling into your cash register.

Early Birds Since automobile manufacturers have found it practical and stimulating to push their show season two months ahead, from early January into early November, makers of refrigerators and other major appliances figure that the same beneficial results may be obtainable in their field.

We have seen the new 1938 lines that are being announced. They offer many new and desirable sales features. They represent bigger values than ever before with correspondingly bigger sales opportunities for the dealers.

While the selling of radio sets should command the careful and continuous attention of every radio dealer, it has been demonstrated that a properly organized separate sales set-up for major appliances will prevent interference

with radio sales and at the same time contribute substantially to the year's net profit.

Trade-Ins In those states where Fair Trade Laws permit contracts for maintenance of retail prices the problem of trade-in allowances is giving radio distributors and dealers no end of trouble.

Several methods have been suggested for solving the difficulty. One provides for a fixed schedule of percentages that are to be deducted from the original cost of the trade-in set, the percentage increasing with age of set. Another calls for a Blue Book which quotes the proper trade-in allowance for each make, type and year of set. (See RADIO RETAILING, June 1937).

Chains A new report on the number of corporate chains, just completed by The National Association of Real Estate Boards lists a total of 9,539 chain systems as compared with 9,785 in 1930 and 4,903 in 1927.

But, in 1936 there were only 8,100 chains on the list so that despite all the new law-made obstacles such as chain taxes, the Robinson Patman law and the many fair trade laws the last 12 months have added over 1,400 new chains to the list.

However, radio dealers need not be unduly alarmed as the increase has occurred mostly in fields that do not handle radio sets. Nevertheless, it will pay any independent dealer to study the display and merchandising methods of his chain competition and wherever possible adapt them to his own needs.

School Radios After using radio as an emergency means of instruction during a recent epidemic, Chicago is taking steps to use radio as a regular and permanent addition to the present educational curriculum.

The plan under discussion provides for special programs to be broadcast

nightly and to consist of 75 per cent of informative entertainment, 15 per cent of purely informative material and ten per cent of strictly instructive matter. High school and other pupils are to be used in the cast; teachers will write the script.

Not every community can plan to present its own broadcast programs for schools but every community can have its schools use to advantage the many genuinely instructive programs that are available during school hours. The study of natural history, music, drama and current events can be profitably augmented and made more interesting to students if class rooms are equipped to tune in on suitable programs, when desired.

It is up to radio dealers to sell the idea to local school boards and superintendents.

Boost Broadcasts After 225,000 personal interviews with radio listeners, covering 233 network programs over a period of 7 months, the Co-operative Analysis of Broadcasting reports that the popularity of broadcast programs was about 30% greater than shown by a similar survey a year ago. That's good news indeed.

Program popularity is quickly interpreted into more frequent and more continuous use of radio sets, which in turn increases the demand for good reception, stimulates the desire for new sets or more sets in the home, broadens the need for new tubes and service. Radio retailers boost their own business when they boost interest in broadcast programs.

Incidentally, the 10 programs leading in popularity, according to this report were: Fred Allen, Phil Baker, Jack Benny, Major Bowes, Burns and Allen, Eddie Cantor, Bing Crosby, Hollywood Hotel, Lux Theatre, Rudy Vallee.



EDITOR

OVER 5,000,000 FARMS NOT YET ELECTRIFIED

*5 out of every 6 Farms are Live Prospects
for Gasoline Powered Washers, Pumps,
Light Plants, etc.*

THERE are 5,719,673 farms not connected to electric high lines according to a government report dated September 3, 1937 . . . meaning that 5 out of 6 farmers are gasoline power prospects. Many of them are right at your own back door. Here's a tremendous market you simply cannot afford to pass up. Dealers who ignore it are now missing substantial sales and profits. Remember, too, that you can get this business quicker and in greater volume if you handle gasoline driven equipment that is powered by Briggs & Stratton 4 cycle gasoline motors. More than a million of them have won the farmer's confidence through unusually long life, economy of operation and trouble-free dependability.

BRIGGS & STRATTON CORP., *Milwaukee, Wis.*



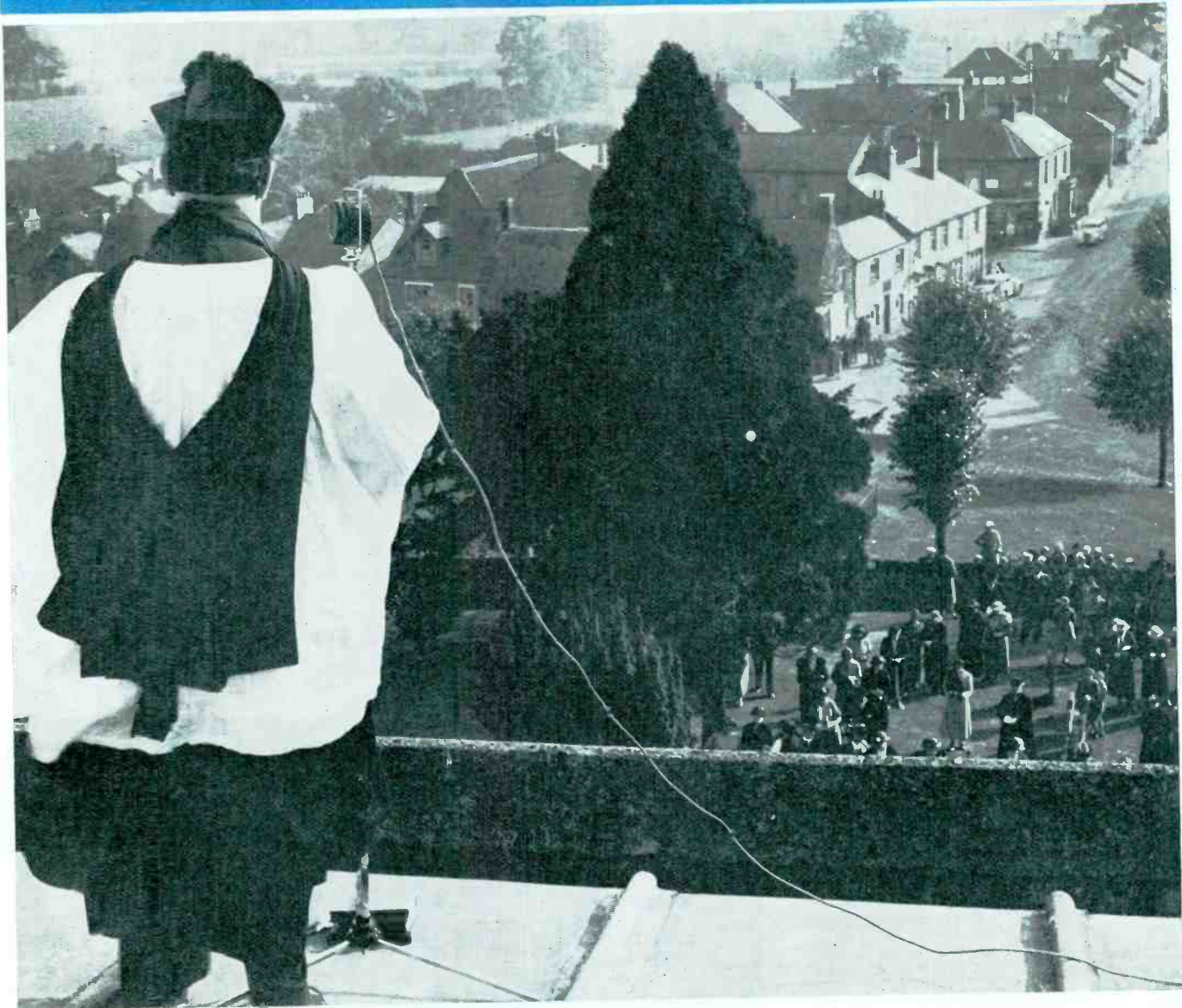

RELIGION FROM THE ROOF

Sound served the Church of England when the Vicar of Earls Barton, Northans, delivered a sermon celebrating a feast from the roof of his church, later relinquished his place before the microphone to the choir.

To hear the Rev. L. Ewart's amplified voice many of his flock gathered in the courtyard of the quaint, 9th century, Nene Valley structure. Others congregated farther back on street-corners. Still others listened through the windows and walls of their homes, powerful loudspeakers carrying the message and music to even the remote corners of the town.

So far as we know an innovation in the application of sound equipment, this news event suggests many similar uses. Here, obviously, is a method by which on special religious occasions the church may carry its message to many more than ordinarily enter the orthodox place of worship. Novelty appeal is high because the average man in the street is not yet grown blasé to the modern miracle of sound, is certain to be attracted by it. Pictorial appeal is present, ecclesiastical frocks providing it in full measure. And the four walls of the church are, as it were, expanded to include all outdoors.

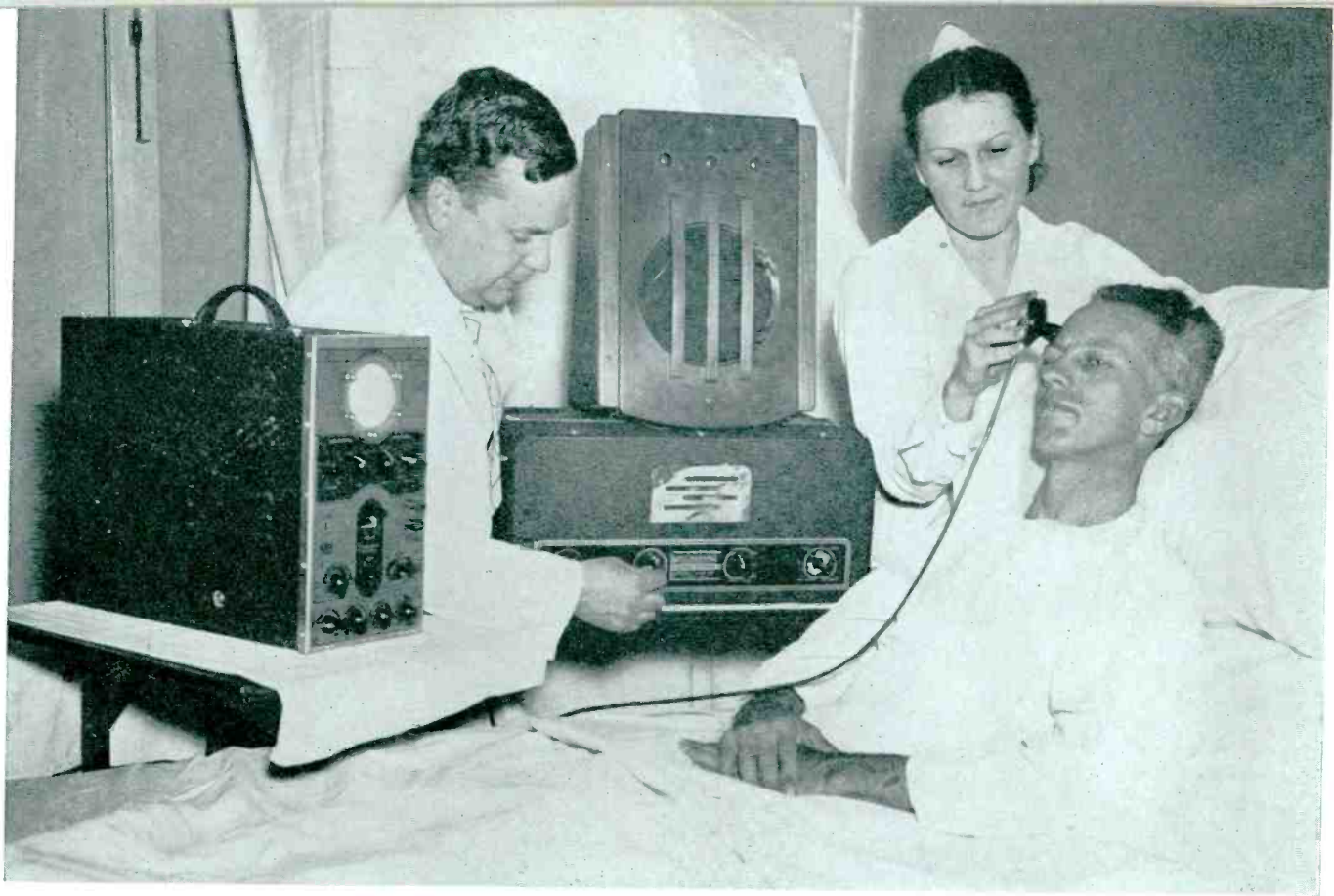

OLD-FASHIONED STETHOSCOPE IS STREAMLINED

Like the intermittent puffing and panting of a steam locomotive slowing down for a stop were noises in the head of George Yokum, Luzerne County coal miner struck on the head by falling rock, when LeRoy Lowe of Philadelphia's Sound Amplification Com-

pany installed a crystal stethoscope and high-gain audio amplifier at his bedside in Temple University Hospital, fed the output to medical students in the auditorium. An oscilloscope showed blood-surge sound visually. Medicos are clamoring for details

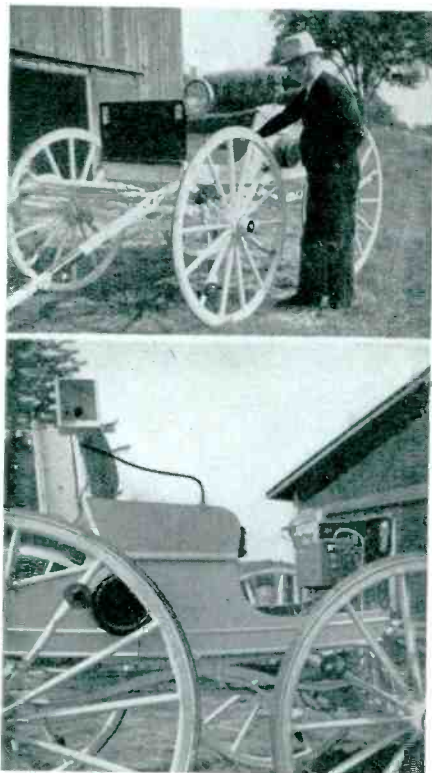

SLEIGH IN WINTER

Auto-radio enthusiast par-excellence is Frank Dyer of Whitewater, Wis., who has so far had seven successive sets in his buggy, refusing to buy a car



JOHN Q. PUBLIC SELLS HIMSELF

Reminiscent of last month's "Mystery in Missouri" (RROct13) is this first-prize winning RCA window installed by A. J. Buzzard of Pittsburgh's Spear & Company. Rigged to permit automatic tuning of a new console in the display, from the street, it effectively sells this year's top set-feature



SOUNDMAN'S NECKLACE

Two wide iron straps with enough hook at the top to slide on and off the shoulders easily helps Lloyd Rentvig of Stoughton, Wis., handle mobile sound jobs quickly



MIKE PARADE

Proper display even moves more microphones. These, in their own demonstration booth, plug in individually, drive speakers in a similar booth next-door

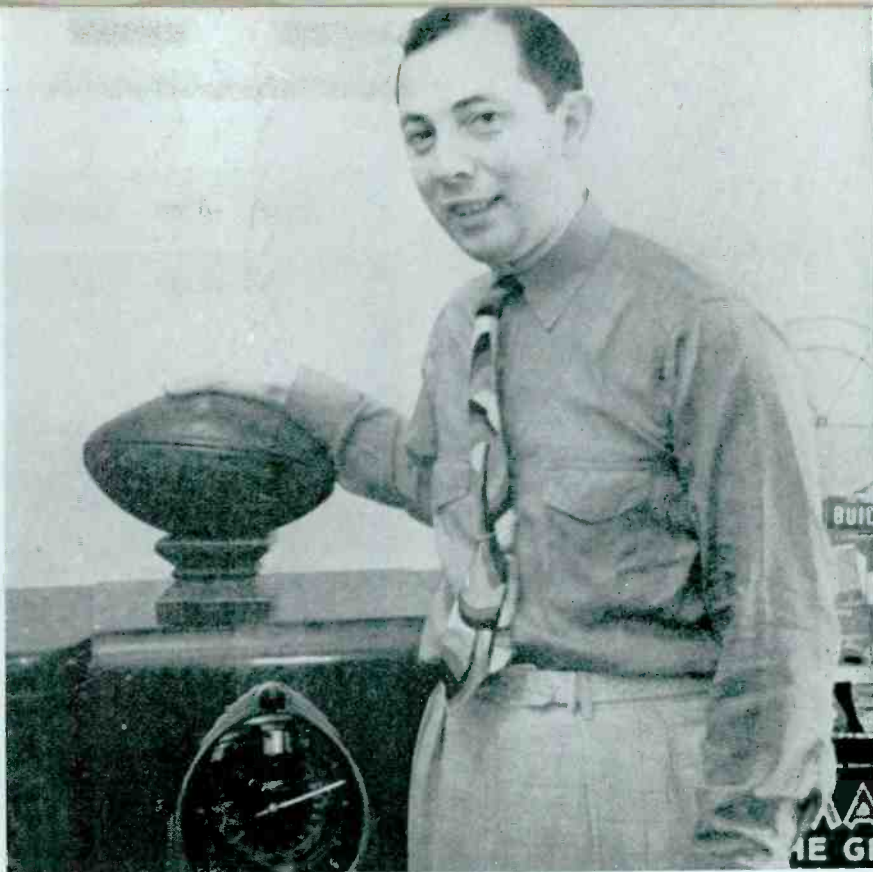

WRITES NAMES ON A PIGSKIN

For Ben Kahn of Columbus, Ohio, footballs autographed by famous players make excellent window and store attractions during the season. Ben supports five local junior teams for publicity's sake, thinks it is the best kind of promotion for a radio and appliance shop, recommends the idea to others

MODERN STORE FOR MEN WITH MONEY

To a clever architect specializing in retail fixtures, Walgreen Drug gave carte blanche when planning a radio department for its new \$1,000,000 store in Miami. Result: Wall mural map with colored lights to show location of chain broadcast stations;

built-in tube-tester complete with attractive, compact stock rack; three-tiered stands for table model set display; modern streamlined furniture. Not in photo: Glass-enclosed studio for playing music to entire store

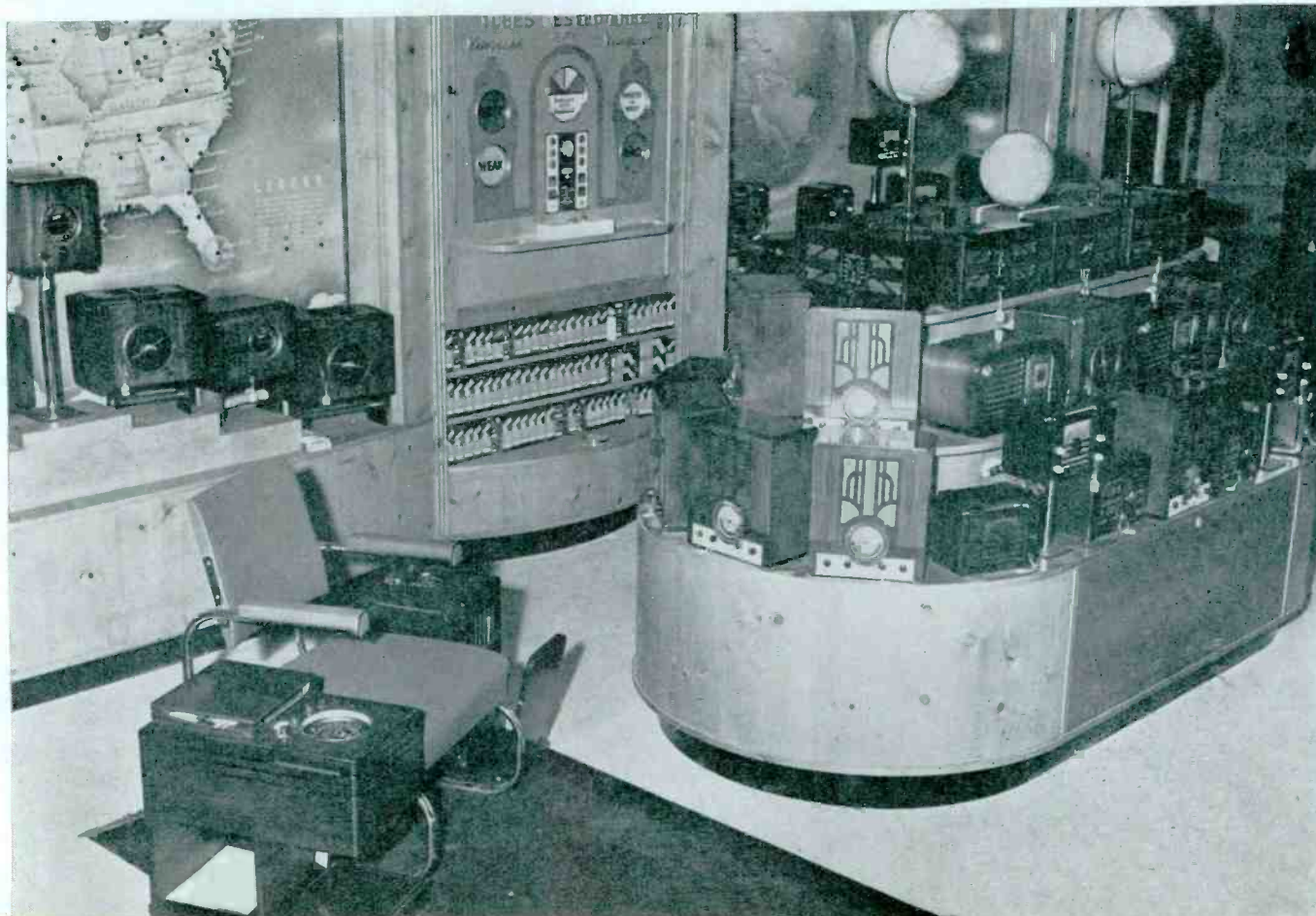

HOW WOULD YOU FIT A

EARLY AMERICAN—Dark blue walls, variety of design in upholstery and lamps. A table model with modern lines should tuck away without disturbing the ensemble

Problem in DECORATION

By **Mary Davis Gillies**
Home Furnishing Editor,
McCall's Magazine



RADIOS are furniture. Maybe that's what *you* think. But if you and the radio industry do, you are both almost alone in your opinion.

For instance, how many model rooms have you seen, during the last year, in which a console radio was featured—or was even included? Pick up any decorating magazine, leaf through the pages and count the radios shown in photographed rooms. If you find even one console radio, it's unusual.

But for all they're being ignored, you know that radios are being sold. However, isn't it possible that more of them could be sold? Isn't it possible that the approach to the whole subject of radios might be advantageously changed? And isn't it possible that the new approach should

be to place more emphasis on radios as furniture? I believe it would be easier to sell console radios if women looked upon radios as they do on pianos—as furniture.

It's quite true that because of their design, console radios have been in disrepute with decorators. Many women have picked up the same point of view and what the woman says about room decoration goes. So, even though the man of the family would very often prefer a large model, because of superior reception, in the small hours of the night he is persuaded to get a table model for the sake of appearance.

So it's the ladies who must be sold on larger models and it's easier to do if radios are considered as furniture.

To sell radios as furniture, the

salesmen must have quick answers and correct answers to two simple questions that will always come up: "Can I use a modern radio in a living room that isn't modern? Where can I put it?"

Naturally this isn't the place nor the time to launch into a discourse on period furniture. However, to answer the first question, you must know what type of room is under discussion and a few simple facts about present furniture trends will be helpful. Dollars to doughnuts, the room will be one of four styles: (1) Early American—that is, maple; (2) Georgian, known also as 18th Century and Colonial, in which either mahogany or walnut is the featured wood; (3) Modern; (4) No particular style.

Even though these furniture styles are running neck and neck in sales, they are also hand in hand because fashion today no longer insists upon or even condones over-period rooms. In fact, it's smarter to mix them up.

In some of the most lush decorating jobs to be seen on Fifth Avenue this fall you will find Georgian, Regency and Early Victorian furniture all in a single room. Also, you will find some purely modern furniture in every room up and down New York. There may only be an easy

RADIO INTO THESE ROOMS?

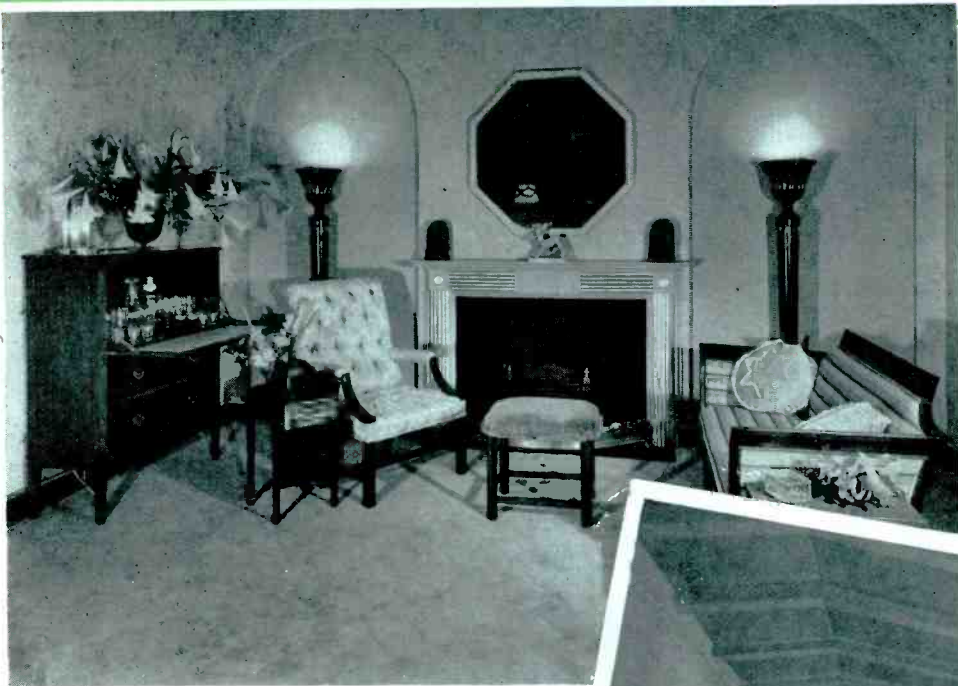

GEORGIAN—But color scheme, fireplace and architectural details are of contemporary design. A simple walnut console could be substituted for the cellarette on the left

MODERN—Still shows early American influence, with painted pine paneled walls, turned leg octagonal table. Almost any radio could be placed in this room if painted white

chair or a square-lined mirror coffee table. But a contemporary note is so inevitable, so natural and so simple that, whether a room is traditional or not, you can't escape some modern notes.

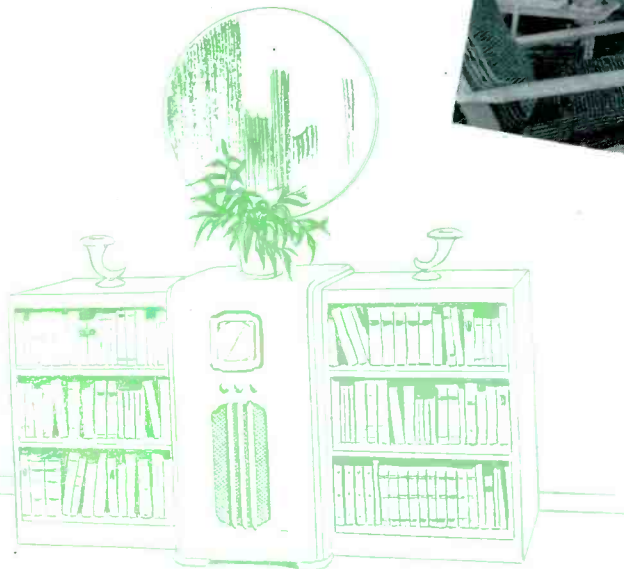

Handling a "problem child" . . . a big console flanked by bookcases

So the answer to the question, "Can I put a modern radio in a room with traditional design" boils down to this: "Yes, you can, because today it is considered correct to introduce

the second question: "Where shall I put it?" In some rooms, ingenuity and imagination will be required to place a radio successfully. The only way to approach the prob-

lem is with an actual floor plan of the room, with fireplace, doors, windows and present furniture indicated. This is the successful approach to range and refrigerator sales and there really seems to be no reason why such a logical approach should not be successful with radios also. Public utilities with kitchen planning services now think nothing of redesigning a whole kitchen in order to assure satisfaction in the new appliances, so I'm not promoting any wild or unheard-of scheme when I say radio salesmen should be able to advise a woman in placing consoles so they will be at

lem is with an actual floor plan of the room, with fireplace, doors, windows and present furniture indicated. This is the successful approach to range and refrigerator sales and there really seems to be no reason why such a logical approach should not be successful with radios also. Public utilities with kitchen planning services now think nothing of redesigning a whole kitchen in order to assure satisfaction in the new appliances, so I'm not promoting any wild or unheard-of scheme when I say radio salesmen should be able to advise a woman in placing consoles so they will be at

home in the rooms in which they will have to live.

The easiest of all radios to place is an end table type, which can be incorporated into almost any room. Moreover, it answers a real need, because, believe it or not, there's not a living room in the country with enough end tables. And I make that

Console models are the most difficult to place pleasantly. The proportions are likely to be awkward, and only through careful plotting can their tall upright shapes be made to relax and become a part of a furniture grouping. After trying one grouping and another, if the radio still seems hopelessly out of place in

have a pair of windows spaced two or three feet apart. In such a room the radio may be placed between the windows with the radio flanked by a pair of chairs or plant stands to give real finesse to the grouping.

Unfortunately, there will always be rooms that are without wall space enough for the bookcase grouping.



Another effective solution . . . console surrounded by bookcases



Perfect location for a tall console . . . between two windows, flanked by chairs

statement after checking over thousands of furniture floor plans. So when you advocate an end table radio you can be quite sure that there will be room for it. Moreover, from a decorator's point of view, end table models can be slipped into a room more unobtrusively than any other type of radio. Tucked away by the arm of a big wing chair, there will be modern invention and entertainment at the finger tips, but only old world charm to meet the eye.

If you are dealing with a living room furnished in maple, the problem is more difficult because the walnut wood finish of most cabinets will loom up against the lighter maple like a fly on white frosting. Deal with such cases boldly. In other words, use paint or lacquer. Cover up that too conspicuous wood veneer with black or antique white paint. With such a finish repeated in another chair or table, even a radio will nestle down with hooked rugs and flower prints.

the room, my solution would be to put the radio in a closet or in a corner behind a screen.

How to Handle Problem Children

Of course to my notion the most successful way to handle a console radio is to make it a part of a bookcase grouping. This can be done whether the book shelves cover a wall or are only pier cabinets. In one case the shelves will completely surround the radio (see sketch). In the other the shelves may be the same height as the radio (see sketch). The purpose of this latter arrangement is to create a horizontal group instead of a perpendicular one, because it is easier to develop an attractive picture grouping over a horizontal wall mass and of course the effect is more restful to the eye.

As yet I haven't mentioned the simplest arrangement. Many rooms

devoid of window pairs, and with floor space too valuable to give up to a screen. Then the only thing to do is to hold your breath, face the facts of life, and work out a corner grouping with a radio, an arm chair and a lamp. In short, a place where a man can relax and be happy. But remember, the chair should be a big comfortable one. Such a group is an open admission that the comfort, convenience and pleasure of the family have not been subordinated to the mere appearance of the room.

However, even in the last arrangement, the radio must be considered as furniture because in order to make the radio convenient other furniture must be grouped with it.

All in all, if more could be done to put radios in the class of furniture rather than that of just musical instruments, the whole sales angle on large radios would be easier to handle.

Learn to sell radio as furniture.

"A STITCH IN TIME . . ."—I PERSON-
ALLY RECOMMEND THAT YOU ASSURE
YOUR SUPPLY OF



KADETTE RADIO

The Christmas Gift of the Year!

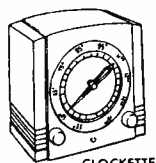

CLOCKETTE



DYNAMIC
JEWEL



CLASSIC



CASE

DE LUXE
PORTABLE

DON'T DELAY ORDERING PLASTICS

First come—first served, must neces-
sarily be the rule in filling orders
for Christmas stocks of Kadette
Jewels, Travel Sets, Classics and
Clockettes. Top speed production is
enabling us to catch up on jobber's
requirements. And we hope to fill
all demands for the holiday trade.

Dealers' orders received NOW will
be scheduled for early delivery.
Furthermore, dealers placing orders
now will be sure of receiving the
free cutout counter and window
displays. The supply of these is
definitely limited. See your jobber
—write or wire—TODAY.

AND NOW! THE LEADER OF THE INDUSTRY

Dealers advertising **\$19.95**
10-tube leader for . . .
acclaim it the greatest producer of
store traffic radio has ever seen!
Increased production now permits
filling additional orders for this sen-
sational K-1019. ACT NOW!

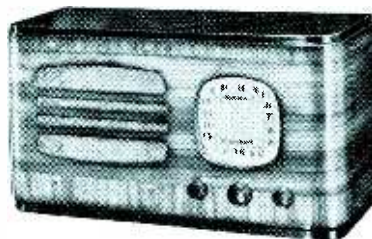

INTERNATIONAL RADIO CORPORATION, 558 Williams Street, Ann Arbor, Michigan



KADETTE

*Creators of
Quality
Compacts*

RADIO COMES *to*

By **George Carr Ganter**
Stratton, Terstegge Co.



HIGH IN THE SUPERSTITIOUS CUMBERLANDS—A console radio is tested after its trip by prosaic truck through the famed "blue grass" region, crated again and loaded into a far more romantic and practical wagon for transportation to that difficult land farther up where Daniel Boone, reincarnated, could walk again and note little change in manner or custom

NOT far geographically from our metropolitan centers, but years behind the culture of our times, are a self-sufficient mountain people just learning of the magic that is radio—thanks to the University of Kentucky that has been establishing "Listening Centers" in these outposts.

Some time ago the Specialty Division of the Stratton & Terstegge Co., Louisville, Kentucky, became interested in these "Listening Centers." Contact was established with the University of Kentucky's Publicity Bureau and Mr. Carpenter of C. F. Brower Co., pioneer furniture and Stromberg-Carlson dealer, of Lexington, Kentucky.

Through the efforts of Mr. Carpenter and H. E. Culley of Stratton & Terstegge Co., a console radio was donated for the establishment of a Center at Elm Rock, Kentucky.

The purpose of the Listening Center is to bring to the people of these remote sections contact with the world in which we live; to stimulate the growth of ambition to go forward that may sleep in the heart of the mountaineer.

Today there are twenty-five of these centers scattered among the mountains and more are to be added as funds or donations make it possible. They are located not by the ease with which they may be reached, but where the "Voice of the Air" has never been heard and where no radio is available within a radius of at least five miles.

At the present time the University has one field supervisor of Listening Centers, Miss Corsia Whitaker, a college graduate and teacher, who walks the mountain trails from one center to another to help the

listeners get the most from the modern miracle of radio. A charming and attractive young lady, she walks, alone and unafraid, trails that would give the stoutest-hearted male reason to pause. No pioneer woman worked for an ideal with more fortitude than this messenger of education who works among these last pioneers of the Twentieth Century—the Kentucky backwoods people.

When one considers that the majority of these people have never seen an electric light or telephone, and may never even see an automobile, one can gain an idea of the tremendous task that faces the bearer of knowledge. Superstition and the natural distrust of the hill folk for a "furriner" add no little to the task.

There you find no radios, no roads, no newspapers, no medical attention. Creek beds serve for trails. Cooking is done in an open fireplace with the aid of a spider; clothes are manufactured at home from the flax to the finished garment. They are a self-sustaining people with the blood of kings flowing in their veins; a proud race living in their own circle without knowledge of the advancement of civilization. Daniel Boone, reincarnated, could walk among them and note very little change in manner or custom. Women work the rocky fields, bear children and are old and worn out at twenty-four years of age.

Leaving Lexington early on the morning of June 22, with the crated radio, Mr. Carpenter and I drove through the famed "blue grass" to Winchester, where we took the "Trail of the Lonesome Pine" made famous by the pen of John Fox, Jr. We followed the Trail through "Blood Breathitt" on into the heart of the Cumberlands. At Dwarf we left the trail and started into Knott County, following the highway to the mouth of Ogden Creek. Up Ogden Creek for nine miles we worked our way, with Mr. Carpenter walking

the KENTUCKY HILLFOLK



ahead to clear the trail for the Dodge. Filling holes where the so-called "road" left the creek bed and measuring clearance for our passage gave him plenty to do and made the nine miles seem like ninety.

At four-thirty we arrived at the end of the "road," at Vest, Kentucky, where the University has a Listening Center. The native who has charge of the radio receiver at Vest took us

(Please turn to page 74)

A MOUNTAINEER'S HOME, HEWED FROM THE FOREST—Here cooking is done in an open fireplace with the aid of a spider, clothes are manufactured from flax to finished garment, a typical meal consists of corn cakes, fried eggs (floating in grease), fried apples, boiled beans with Sorghum molasses for sweetening . . .

THE PAUSE THAT REFRESHES—Behind two red mules, the author travels the storied "Trail of the Lonesome Pine" through quaintly named "Blood Breathitt," Dwarf, Vest, Troublesome Creek, Bald, Quicksand . . .



END OF THE TRAIL—At the University of Kentucky's "Listening Center" in Elm Rock, Mr. Carpenter and Corsia Whittaker, who walked 19 miles to guide him in, unpack the donated set, prepare to demonstrate it to people who have never seen an electric light or telephone, may never see an automobile . . .

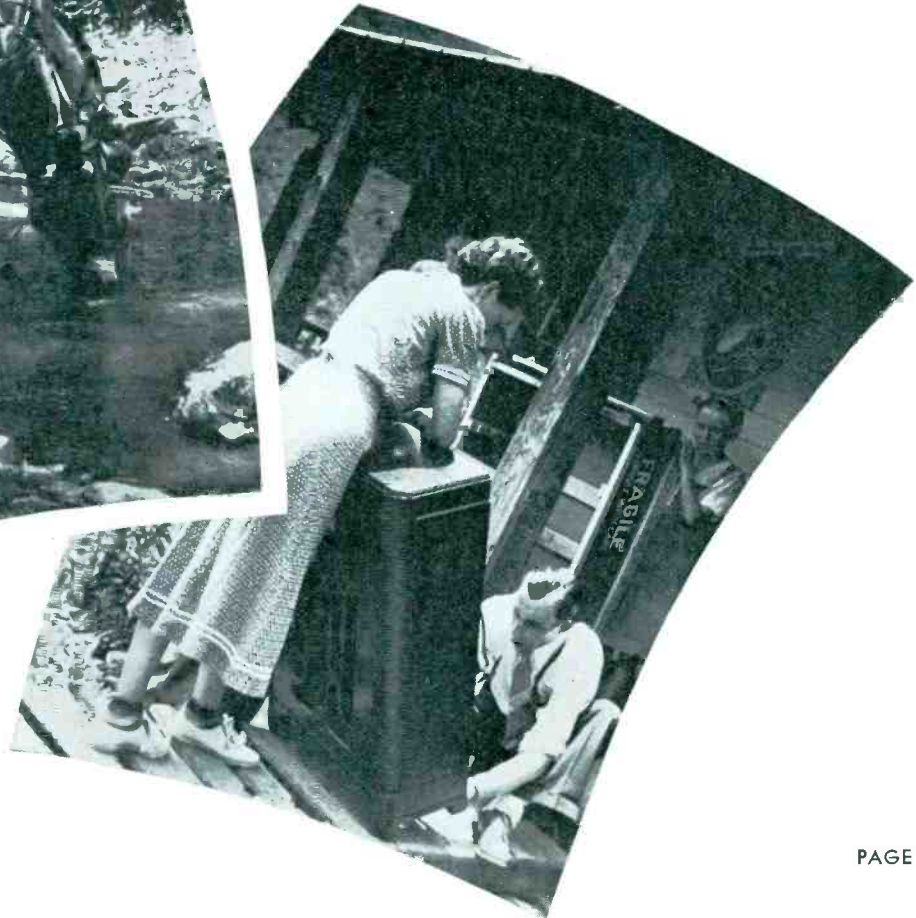



Foremost among physical requirements is ample counter space for display of best-sellers, racks permitting speedy location of wanted discs and instant appraisal of stock condition

Getting

Started

WITH RECORDS

By RICHARD GILBERT

FIRST of a SERIES

Next Month: How to Keep From Overstocking

RADIO retailers are conscious after three years of phonograph prosperity of the profit possibilities in records. In view of the intrinsic merit of records as a medium for home entertainment, the business promises to remain stable.

Average radio dealer's prime posers when on the verge of putting in the black platters: How large an inventory do I need? How often should I turn it over? How can I keep from overstocking?

Before answering those questions a number of equally important considerations should be pointed out. Have you thought of the space you will need for the successful merchandising of discs? Will you be able to keep a weather eye on all details connected with a record busi-

ness? Can you supply adequate listening booths and reproducing instruments for demonstration? Will you shelve your stock and display it with the same regard as you have for higher priced units? Will you hire someone to sell records exclusively rather than leave the job to one of your present salesmen who may not evince much interest in discs?

Records can be handled profitably, as successful dealers throughout the country have demonstrated, only when you plan a layout such as we have sketched below.

A wise merchant knows the value of having his fastest selling stock near the main entrance. Low-priced items bring in more customers. Dance disc purchasers are always prospects for new radios, phonographs, service jobs. Radio buyers can't overlook the fact you sell records.

A managerial eye on all the facets of the phonograph field is necessary

if you want to learn to sell as well as to buy without overstocking. The secret of leading dealers' success is to know latest trends in dance discs, popularity of radio artists who record, sort of serious music clients prefer. Understanding these things, the probable market for new releases no longer appears problematical.

Special demonstration facilities to attract buyers to your shop are highly important. You need a minimum of two sound-proof listening booths, comfortably roomy, equipped with modern reproducing instruments to do justice to the amazing fidelity of present-day recordings. Good booths can be built at an average of \$100 each; if you supply the labor yourself, for much less. Johns-Manville acoustic material is excellent; if you can afford it, do so by all means. Plaster is better than unfinished celotex. Stagger the studs and slip an extra partition in the middle leaving

(Please turn to page 74)

By
O. Fred. Rost

IN the news of the day is the issuance by the Federal Communication Commission of *commercial* television licenses. On the market this month plainly tagged: "For experimental *television* receivers" are two new cathode ray tubes. In the news is purchase of a 7,500 watt video transmitter by the country's second largest radio broadcasting chain.

While even these significant happenings still leave prognosticators up in the air as to the probable date of television's commercial debut there is sufficient smoke to suggest that it has moved forward from the indeterminate to the immediate future. Already speculating is the industry regarding the reaction of radio retailers to television when it comes. How will the trade go about selling it? What, initially, will be the consumer's reaction? Will it be national in coverage? And what will be the effect on audio equipment sales? These and similar questions are anybody's to speculate about. There is one yardstick, however, which appears to us more practical than the usual comparison with early radio experience.

The British dealer as well as the British consumer may be psychologically different from the American. Nevertheless, as a yardstick, the facts uncovered by practical experience with television in England appear indispensable to the radio industry of America at this time.

For this reason the Editor has just concluded a six weeks close study in and around London, concentrating on the commercial rather than the technical aspects of the business. He presents herewith a personal report of his findings.

LONDON, England, October, 1937—Radio dealers who have looked upon television as some strange shadow on the horizon would quickly change their viewpoint if they had an opportunity to see for themselves what I have seen here in England, where commercial television has had the stimulus of regular daily broadcast programs for the last 14 months.

Fact of the matter is that in England *radio* manufacturers make the television sets, *radio* dealers sell them and *radio* service engineers do the honors when it comes to troubleshooting, all of which indicates that television is just another baby of the radio industry—like loudspeakers, windchargers, battery chargers, sound, are radio's babies—and as such, when it is commercialized in this country, will fall inevitably into the lap of radio dealers.

RADIO RETAILING, NOVEMBER, 1937

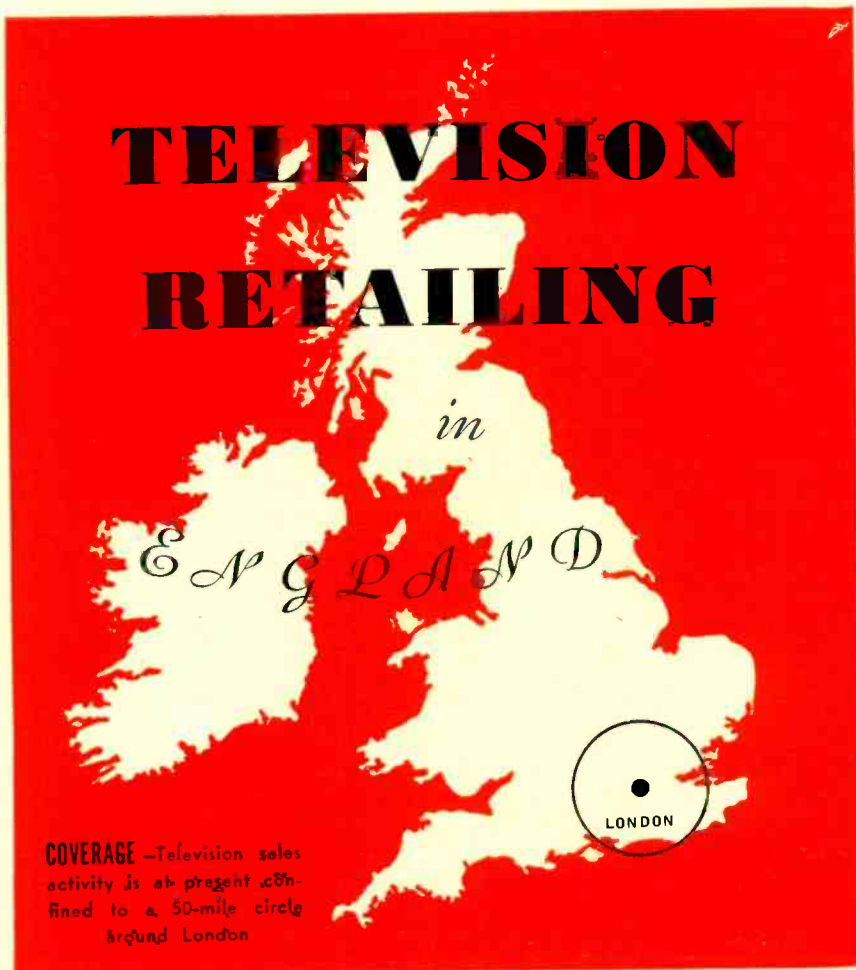

Some of the British radio retailers admit that they began worrying about the future of radio set sales when in August, 1936, the British Broadcasting Corporation (government owned and operated) began to transmit regular video programs with resulting great public excitement. In fact, with some dealers, set sales went into a slump, but the slump was comparatively short lived.

Set manufacturers and dealers simply cooperated in acquainting the public with some of the characteristics of television. And saw 80 per cent or over 30 million British subjects, who lived outside the zone of effective television reception, go back contentedly to their radio sets. They would wait until a broadcasting station was put up near enough to their homes to give them effective reception.

Within the London area, where the video programs that are broadcast daily from Alexandra Palace can be received with some degree of satisfaction, I found the situation somewhat different.

Thousands of people wanted to see television demonstrated. Hundreds thought they would want to buy a

receiver. But the cheapest television receiver on the market at that time was priced at £75—equal to \$375 in American money. And there were only two hours per day of video broadcasting. With such limited usefulness for a very expensive instrument, dealers found that most of the prospects decided in favor of the much less costly radio sets that would give them 24 hours per day of usefulness.

Sales to Date

Although public interest in television has grown steadily since the beginning, the two limiting factors, namely the high price of sets and shortness of programs, naturally cramped progress as far as sales were concerned. For that reason the world's pioneer year of commercial television, ending August, 1937, produced for manufacturers and dealers a comparatively small volume of television set sales.

When I totaled the sales of all the manufacturers I found that within the London television area, where there are over 3,000,000 radio sets in use, the first year of commercial television—August, 1936 to August,

PAGE 23



TRANSMISSION—Televising an outdoor scene. London Alexandria Palace ultra high frequency video and audio stations in background.

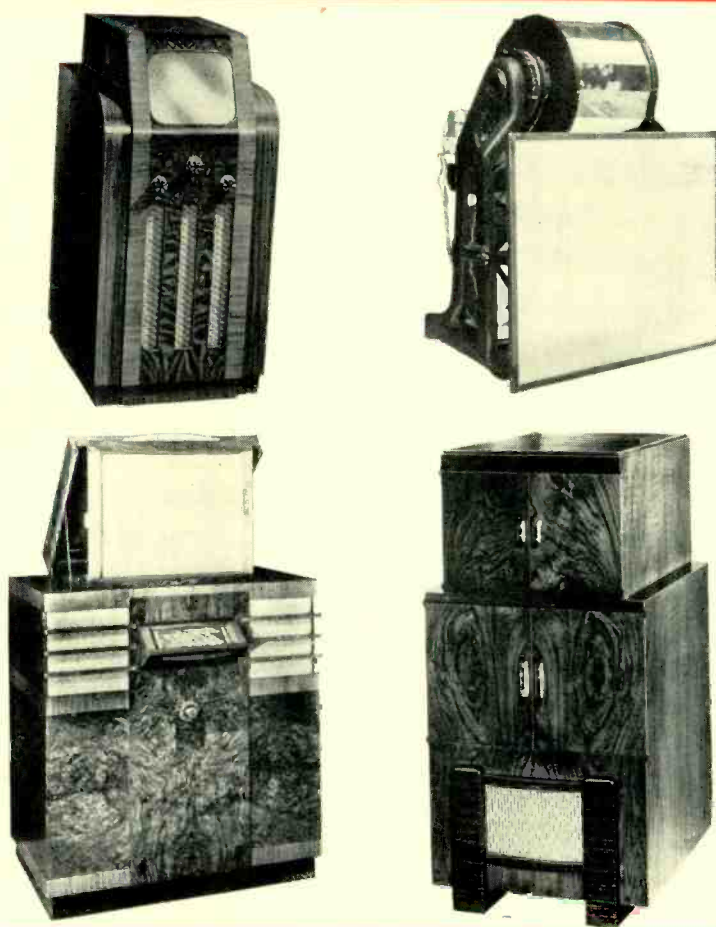

1937—had resulted in the actual sale of approximately 1,350 receiving sets to various types of buyers.

In this connection the specific performance of individual manufacturers will provide some interesting sidelights.

For instance, one important radio set manufacturer who offers a finely designed and reasonably priced line of television receivers sold about 200 sets during the first year. Out of 2,000 radio dealers within the television area handling this maker's radio sets, approximately 120 were carrying television sets in stock.

Another widely known company, whose radio sets are handled by 4,000 dealers, has about 100 retailers on its television list and sold slightly over 300 sets during the first year.

A third company of high standing, which pursues a rather rigid sales and credit policy and selects its dealers with great care, has 1,500 outlets for its radio sets in the television area, and just 300 of them are stocking and demonstrating television sets.

This company has taken the lion's share of all sales made up to August, 1937.

Second Year Prospects

Since commercial television in England completed its first year in August, 1937, several things have happened to justify the expectations that during its second year sales will probably total 10 times the number scored in the previous period. The three important factors expected to contribute most to that increase are as follows:

(1) The second year got off to a flying start with the holding of "RADIO OLYMPIA", Great Britain's great annual radio exhibition. Every radio manufacturer who had television sets to offer was on the job with specially built demonstration booths and these were crowded to capacity during all transmitting periods, this resulting in much stimulation of public interest.

(2) Several manufacturers decided

to lick the problem of too high prices by eliminating the duplication of certain units. They offered table models or small console type of television receivers that are hooked up to existing radio receivers for sound reception. These are priced at £35 to £55. (\$175 to \$275) and, of course, have greatly widened the potential market.

(3) The British Broadcasting Corporation has added one whole hour of video programs per day, thus increasing by 50 per cent the daily periods of transmission. That added hour is from 11 a.m. to 12 noon and is provided chiefly so dealers may have more and better opportunities for demonstrating and for testing and servicing activities.

Just how much these factors have served to improve the outlook for television set sales already has been demonstrated.

One manufacturer sold during the first month of the second year of commercial television as many sets as he did during the last 4 months of



TYPICAL RECEIVERS—Included are table models and consoles, cathode-ray and mirror scanning, direct, lens amplified and reflected image view systems.

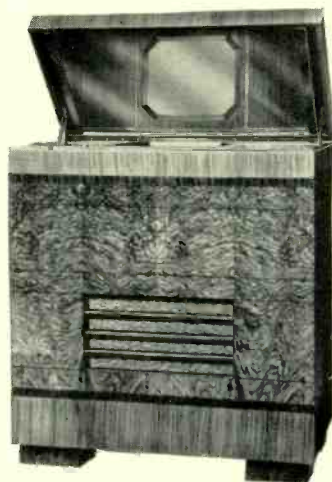

DEMONSTRATION—This television room in one of London's most modern radio shops attracts 800 visitors per day. Sales average two receivers per week.



the first year. Another important maker has found it necessary to quadruple his manufacturing schedule for the rest of 1937 and believes that he will sell during the last 4 months of 1937 three times as many television receivers as he did in the 12 months previously. Several other manufacturers of radio sets are now going actively after television business, having used the first year of regular video transmission to perfect their product, and for training dealers and servicemen.

Retail Profit Possibilities

Naturally, at this point the question arises as to why only such a comparatively small number of the many thousands of radio dealers who are located within the television reception area are actually trying to sell television sets and here again my study developed very logical reasons for this condition.

The most important of these is that at present the potential profits on the sales of television receivers

are too small to attract the permanent interest of the wide-awake British retailers, particularly now that the first flurry of public excitement has passed. This in spite of the fact that British radio dealers do business on a much smaller margin than their American brothers.

For instance, the British retailer of radio sets gets only 25 per cent to 30 per cent discount if he does not maintain his own service department and averages 33½ per cent discount if he does service his own sets.

On television receivers most of the manufacturers still keep their fingers completely on the situation by supervising or actually making the home demonstrations, by completing the installations of sold sets and by providing the necessary engineering service for one year at no extra cost to the purchaser.

This means that the British retailer who takes up the sale of television sets actually is little more than a sales agent for the manufacturer and his compensation is little more than what

a sales agent would get. To be exact, the retailer who does *not* stock television sets but gets a television prospect receives 10 per cent if the manufacturer succeeds in making the sale. If the dealer himself stocks and demonstrates television sets he gets 20 per cent discount and he himself must handle the financial part of the transaction, although the manufacturer makes the installation and gives free service for one year.

I took occasion to discuss this matter of low discounts on television receivers with several manufacturers and received from each practically the same explanation. They contend that television sets are really sold far below what the price should be. If normal production costs, overhead and a reasonable profit were figured in, as they are figured on radio sets, a television unit would retail for £100 (\$500) or more.

Manufacturers are taking a licking on every sale but they intend to carry on in order to show their willingness to cooperate with the British

government in its efforts through BBC to build a television industry. Naturally British retailers are expected to be equally patriotic and hence must be satisfied with those low discounts.

As a business proposition this means that dealers who want to sell television sets must invest in a single receiver as much money as it takes to buy a whole flock of radio sets and when they make a sale, which generally involves considerable trouble, time and expense, their profit is just about half of what it would be on an equal volume of sales of radio sets. The natural result is that at the present stage the business has no particular attraction from a profit standpoint.

However, quite a few British dealers have found that television demonstrations in their home or store are an excellent means of advertising and therefore they stock the television equipment as a means of bringing people to their stores and boosting sales for other merchandise.

Dealer Experiences

Another obstacle to large sales has been that television demonstrations in the dealer's store are rarely if ever sufficient to clinch a sale. This is due to the fact that regardless of the technical perfection of the set itself, the degree of satisfaction of individual purchasers depends to a great extent upon the location of the set when in the consumer's hands and the amount of local interference existing in the neighborhood.

For instance, trolley cars, trolley buses, automobiles, motor trucks, traffic signals, cause serious and often disastrous interference at the present time. Radio dealers may have the finest retail location in the neighborhood and at once the poorest location for demonstrating television.

This matter of local interference has become so important a factor in British television selling that the most reliable manufacturers insist on sending their own engineers for the purpose of making interference and reception tests *before* they permit their dealer to accept the order. There are many cases on record where ready, able and willing buyers were unable to get hold of a television receiver because the proposed location offered such serious and incurable interference, that no manufacturer was willing to have his equipment in use under such conditions.

In addition to those practical dif-

iculties, the financial requirements involved in providing proper sales and demonstrating facilities for television equipment are in the minds of most radio dealers at present entirely out of proportion to potential returns. For instance, it requires at once a separate show and demonstration room which must be darkened completely during demonstrations.

Since the potential purchaser of any television set will be investing a considerable sum, he cannot be expected to accept demonstrations under primitive or cramped conditions which means that the general show room of television dealers as well as the television demonstrating rooms must be pleasing in appearance, well decorated, attractively furnished and properly ventilated. One British manufacturer expects to have demonstrating rooms air conditioned during the summer months.

All these things call for expenditures which, when added to the cost of television receivers and demonstrating equipment, generally involve more money than the average radio dealer is willing to put out until the obtainable volume of sales justifies the investment.

Finally, dealers who have carefully investigated the sales opportunities of television sets generally have come to the conclusion that the growth of sales to sizable proportions depends upon the growth and improvement of video programs.

They admit the recent addition of the third daily one-hour period of broadcasting is a valuable step in the right direction but when dealers as well as private users of television receivers are asked for their opinion on the type of programs that BBC broadcasts, their expression generally is not complimentary.

Thus the British retailers who are located in the television area and who either prefer or are forced to watch their operations closely, are letting some of the bigger stores and the manufacturers carry the expenses and troubles while television is having its growing pains. Most of them admit they will come in just as soon as they think conditions are "right" and, of course, opinion as to when that will be varies with each individual.

In this connection the experience of one large London retailer is significant in that it demonstrates emphatically just how much momentum has been gained in television sales since the 1937 Radio Olympia at which time the three factors previ-

ously enumerated started to exert their influence.

This dealer had maintained television show rooms ever since video broadcasting started. His sales averaged less than two sets per month. Since the 1937 Radio Olympia his demonstrating room is crowded during each broadcast period and sales are averaging better than two a week.

Consumer Reactions

My study of buyers of television sets disclosed some interesting facts.

Of course I was unable to obtain the information necessary to the proper classification of all buyers but obtainable data showed that as a group, stockbrokers and others in the easy-come-easy-go class are in the majority.

Crowding closely for similar honors is the class made up of operators of saloons, roadhouses, clubs, who, according to some manufacturers, lead all other types of buyers. These operators have found that a television receiver acts as a magnet for new patrons and keeps more old ones coming, with the result that increased receipts due to this attraction easily pay for the expense. In some cases average receipts in such establishments more than doubled and some proprietors were considering the purchase of additional units.

Among the buyers have been many of the so-called upper middle class who live quietly in the suburbs or country districts and who welcome the new medium of entertainment.

Significant is the fact that very few of the rich and well-to-do have bought, the explanation offered by several sales managers being that as a novelty or curiosity a television set has no interest for that type of people and when they want entertainment they can afford to buy it in various other ways.

In my effort to obtain a cross section of consumer reactions to television reception I was balked in many quarters by the well known British reserve and reticence.

There appeared to be general agreement that television holds tremendous promise for the future and regardless of the make of set involved, most of the users expressed satisfaction with performance and particularly with the service and attention received from the makers.

In an early issue RADIO RETAILING will publish an up-to-the-minute report on the present status of television in the United States.

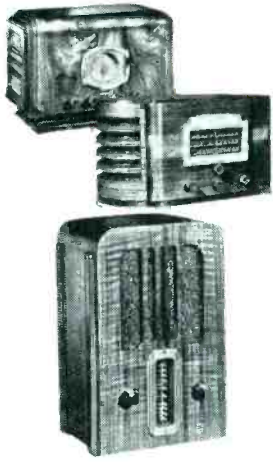
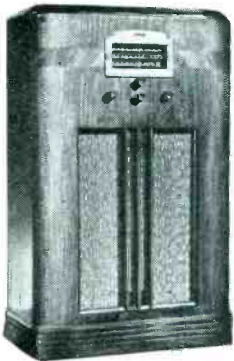

Table Models cover every need from "price" models to fine musical instruments.



Arm-Chair Models meet radio's latest style trend — and add new convenience in tuning.



Console Styles in rare woods and the latest designs cover every price range.

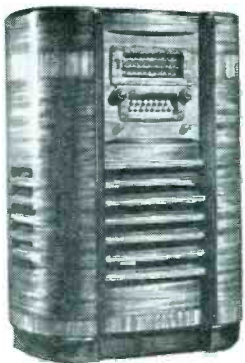

... **Magic Keyboard Models** surpass anything known before in radio value and superb performance.

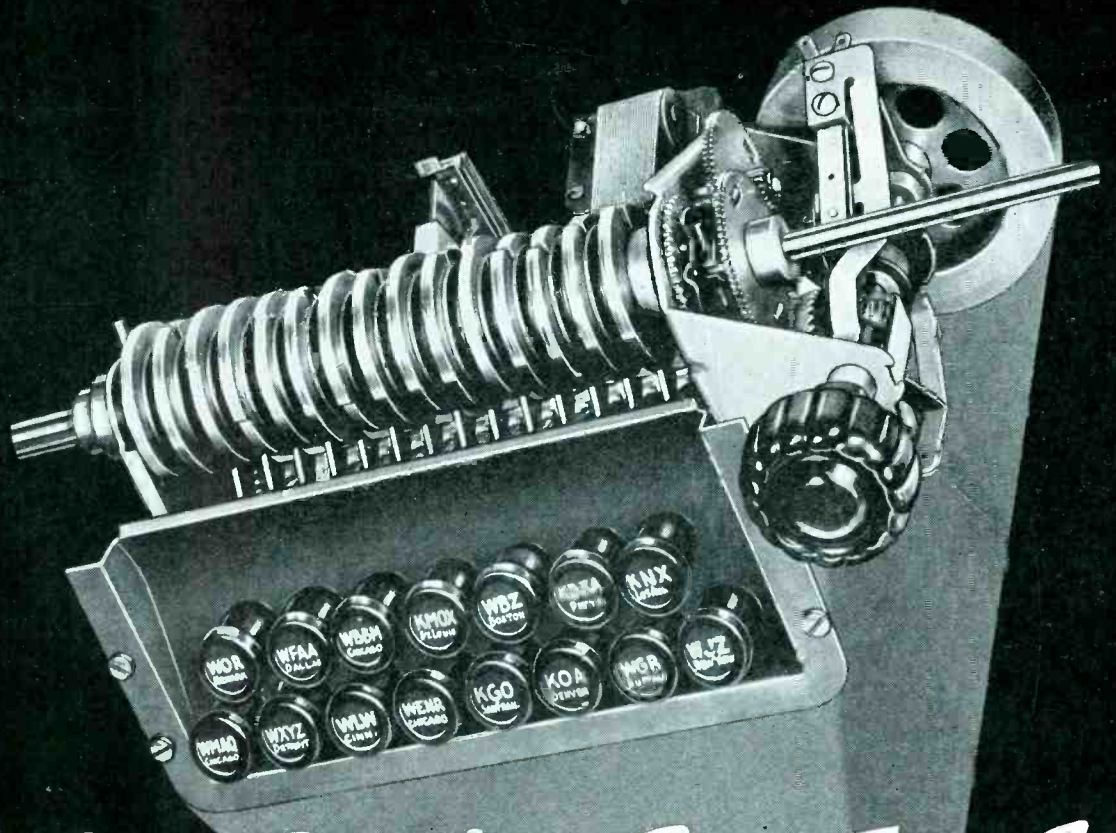

Every Day Adds Proof That It's **RADIO'S HEADLINE NEWS**

A LANDSLIDE of approval has greeted Stewart-Warner's sensational Magic Keyboard everywhere — because it leads in . . .

SPEED . . . goes direct to the station instantly! **FLEXIBILITY** . . . takes any 15 stations in any order! **SIMPLICITY** . . . adjusts from the front, without tools! **QUIETNESS** . . . no hum or buzz! **EASY OPERATION** . . . no hand switches to forget! **ACCURACY** . . . no big errors to require excessive A.F.C.!

Add the complete range of models and prices — the exclusive Stewart-Warner-C.I.T. Sales Finance Plans — Horace Heidt's hard-selling Coast-to-Coast broadcasts — and you'll see why it will pay to get the whole story now!

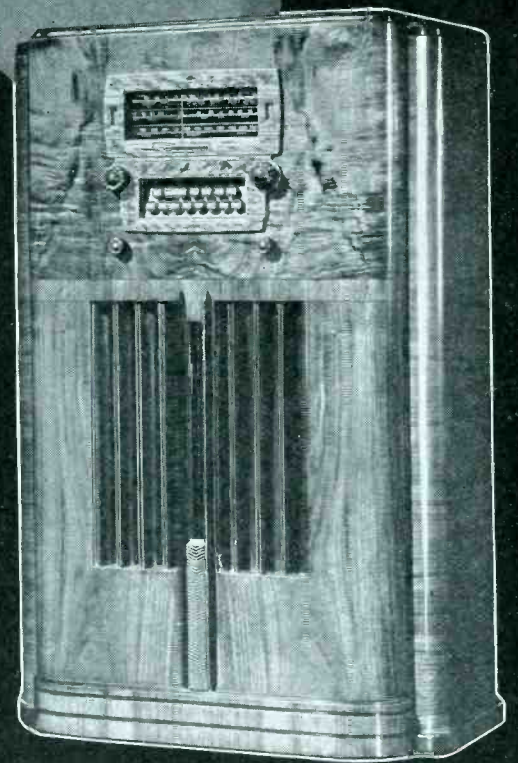

STEWART-WARNER MAGIC KEYBOARD



SHOW

DEMONSTRATE THE DEVICE— Put a unit up near the man on the woodpile, another on the cashier's desk. Unreel a temporary connecting cable between the two. Unreel your sales talk only after the equipment has actually shown its worth

A clerk at Minsky Brothers lumberyard jiggled a telephone on the hook. He wanted to talk to the warehouse.

"Line is busy," trilled the operator.

The customer meanwhile twisted his ankle, looked out the window and drummed on the plate glass. Four minutes passed by before the clerk got the dope from the warehouse. Meanwhile other customers fumed and fretted as this telephone jiggling went on and on.

When Ralph Silverman, director of sales of sound equipment for Hamburg Brothers, Pittsburgh, dropped into Minsky's he didn't say, "Mr. Minsky, I've got something new in sound equipment to show you." No, he actually said, "I think that we've got a way that will



MAN BEHIND THE IDEA—Ralph Silverman of Pittsburgh's Hamburg Brothers developed the "preliminary survey system" to sell inter-communicators

help you to handle your customers more quickly, no matter how far away your warehouse is." With a helper he carried in a couple of intercommunicating systems and a reel

By TOM F. BLACKBURN

BUSINESS It Needs Sound

of wire. This was strung loosely from customer's desk to warehouse while the Minsky's looked on.

"Now press that lever and ask the boy on top of the ladder in back of the warehouse what he is doing," commanded Ralph Silverman.

From the top of the ladder came the boy's answer. He didn't have to lay down what he was holding or be near the system to have his voice picked up. Tom, Dick or Harry, working in the same warehouse could be as easily talked with and each answer back in his turn. Those four-minute waits on the telephone lost a lot of money to Minsky's and they were quick to see what an intercommunicating system meant in dollars and cents.

"The sale of intercommunicating systems requires a preliminary survey," Ralph Silverman, who has put the Hamburg Sound Equipment Department into the black in three months, told *Radio Retailing*. "Every prospect has to be sold on how our Teletalk will save money for him on his particular job and this requires a visit to work up a story."

Right now sales in Pittsburgh on intercommunicating systems are av-

eraging around \$150 apiece. All are cash and are sold to businesses anywhere from clothing stores to lumber yards.

"Prospects whose departments are scattered around quite a bit, possibly on several floors, are meat for intercommunicating systems," Frank Baumgarten of Tri-State Electric, factory representative, declared. "A two day trial is plenty of time to give a prospect. Don't permit any joy riding. There are no trade-ins to accept, and inasmuch as business houses are close together a salesman can get over his compact territory rather easily. The first thing to do in setting up an operation is to get some 50 or 60 big name installations that everybody in town will recognize. The next thing for a radio dealer to do is to call on the same type of people that typewriter or office supplies companies call on.

"Now I admit that the average radio salesman is not used to calling on business firms," Mr. Baumgarten said. "For this reason there has sometimes been an erroneous feeling that office supply firms are logical distributors of intercommunicating systems, despite the fact that they know nothing about radio and are in no position to service installations.

"The weakest spot in the radio dealer's set-up," said Mr. Baumgarten, "is his rapid turnover of salesmen." Intercommunicating systems take several weeks' gamble. The men have to be coached so they can present their proposition intelligently to various kinds of firms. Any radio salesman who has a business viewpoint can succeed at this. Out of twenty calls two or three prospects will be found. A man can quickly become self-supporting.

Hamburg Brothers, down at 305 Penn Avenue, are distributors. Nevertheless they maintain very



FIND FOOLISH FOOTWORK—In the lumber business, for instance, office employees run themselves ragged relaying orders from the customer's window to the yard

INTER-COMMUNICATOR MERCHANDISING ADVANTAGES

Not much walking. Business prospects are close together.

You can use money-saving, time-saving arguments, best of all reasons for buying.

Businessman prospects give quicker action than any other types.

There are no trade-ins.

The customer's credit is usually good.

complete display rooms for the benefit of little dealers who wish to show prospects complete lines of stocks. In the sound equipment end Ralph Silverman first set up a retailing basis with the idea of discovering the bugs in merchandising intercommunicating systems. He has seven men selling. Later, with the proposition working, he planned gradually to turn the retailing over to dealers. That day arrived three months after it started and when *Radio Retailing* visited the store, already distribution through dealers was beginning.



THE BIG NEWS IS OUT!
EXTRA!

26% MORE

Far-reaching Improvements Built Around Patented
Conservador
Sales-clinching Features Ever Offered!



NO CRAMMING. No crowding. No wasted space because of cluttering. That's why the new Fairbanks-Morse refrigerator with its *patented* CONSERVADOR holds more food than other refrigerators of the same size—that is why 26% more quickly usable space can be *proved*. You can instantly show why this refrigerator saves time, work, and *money, too*. Any man or woman can *see* why there is no hunting, no shifting, no spilling, no stooping. Frequently used items are kept instantly at hand in its exclusive CONSERVADOR—a *shelf-lined* inner door. No other refrigerator can match the 26% more quickly usable space it creates—*none can equal its convenience!*

In addition to the F-M *patented* CONSERVADOR—the feature that makes this refrigerator the only *outstandingly different* refrigerator on

the market—this one has every other desirable feature. Big, roomy, automatically lighted main food compartment. *Lower operating cost* that you can back with nation-wide proof of Penny Meter economy. Self-sealing Crisper. Sliding Fruit Drawer. Instant Ice Cube Expeller. Surplus power eliminates all heat wave complaints and service. Illuminated radio-type Temperature Control Dial. Reserve storage compart-

ment for extra supplies. These, plus the Fairbanks-Morse name and reputation, are all reasons why you can close more sales with this new line.

ACT NOW

Here is the best-looking and easiest-selling line of refrigerators available. It is backed by *different* promotion and advertising plans that will close more sales. There is real profit in it for you. Write, phone, or wire now for the complete story. Fairbanks, Morse & Co., Home Appliance Division, 2060 Northwestern Ave., Indianapolis, Indiana.



Sell Something
DIFFERENT
in 1938!

It's a Balanced Program

The Fairbanks-Morse Home Appliance franchise can include refrigerators, radios, and home laundry equipment. You may qualify for one or all in your territory. Investigate now.



FAIRBANKS-MORSE

REFRIGERATORS • RADIOS • WASHERS • IRONERS

**EXTRA!
QUICKLY
USABLE**

SPACE!"

"MORE SALES-CLINCHING
NEW FEATURES"



"SAVES
TIME, WORK,
MONEY"



"TWO-FIFTHS OF ENTIRE
CONTENTS CAN BE REMOVED
AND REPLACED WITHOUT
OPENING MAIN FOOD COM-
PARTMENT AND EXPOSING
ITS CONTENTS TO WARM AIR"



"NEW
ICE CUBE
EXPPELLER
SNAPS ICE
CUBES OUT
INSTANTLY"



"THE ONLY
REFRIGERATOR
THAT OFFERS PROSPECTS
SOMETHING DIFFERENT!"



"NEW, STREAMLINED BEAUTY
THAT SELLS ON SIGHT"



"26% MORE QUICKLY
USABLE SPACE BECAUSE OF
THE CONSERVADOR"



"DIFFERENT
PROMOTION
AND ADVERTISING
PLANS THAT WILL
CLOSE MORE SALES"



"TWICE AS MANY
THINGS AT YOUR
FINGER TIPS"



"LOWER
OPERATING
COST PROVED
IN PENNIES BY
PENNY METER TEST"



"ILLUMINATED
RADIO-TYPE
TEMPERATURE
CONTROL DIAL"

"RESERVE STORAGE
COMPARTMENT
(NONREFRIGERATED) IN
ADDITION TO THE 26%"



"BACKED BY 108 YEARS
OF ENGINEERING EXPERIENCE"



FAIRBANKS-MORSE

REFRIGERATOR WITH *Conservador*



THE recent action of the major sales finance companies and banks to restrict instalment terms on radios and other household appliances has focused the attention of everyone in the industry on instalment selling—its good points—its evils—its potential headaches.

Reams of white paper have absorbed gallons of black ink in the attempt to convince the retailer how fortunate (or unfortunate) he is to be able to sell on larger down payments and shorter terms. Opinions are varied. Some like them long; some like them short; some don't like any sort.

The National Retail Dry Goods Association and The National Retail Furniture Association, representing, respectively, the most prominent department stores and furniture stores in the country, have lent considerable support to the curtailment of credit terms on appliances. Their members for the most part employ their own funds in the financing of instalment paper, which gives them a natural incentive to cooperate with the finance companies and others in their program. Like the credit companies, the department stores and furniture stores are investing good dollars in the future ability of the purchaser to pay out his contract many months hence. Being neither prophets nor gamblers, they feel that eighteen months, rather than twenty-four months, is a sufficiently long commitment at this time.

Specialty appliance dealers are somewhat more divided in their opinions as to the wisdom of cutting terms. Some believe that many of their low income prospects will now be discouraged in the thought of buying because of the larger down payment and larger monthly payment requirements. Furthermore, they feel that those of this group who do buy will find it more difficult to maintain payments for the same reason. These dealers, of course, fail to realize that the incomes of all classes of purchasers have increased in far greater proportion during the past two years than the corresponding increase in down payments and monthly payments of today over those in force up to the present time.

WHY Credit Terms *have been* SHORTENED

By **T. O. McDavid**
Commercial Credit Company

One complaint the radio dealer might make in regard to a tightening up of credit terms is that many department stores, furniture stores and public utility companies have not fallen in line with this program and they now hold a competitive sales advantage over the dealer, particularly on the higher priced products. It is hoped that these groups will see the wisdom of falling in line with this movement which will then hurt no one and undoubtedly benefit all engaged in merchandising appliances.

Certainly the possible sales advantage of offering monthly payments of \$1.00 or \$2.00 less is more than offset by the certain disadvantages of giving the customer too much rope. The records of the finance companies show that during a period of prosperity and easy spending, such as we are enjoying today, many people are inclined to over-extend themselves. Since their credit is satisfactory at the time and their future outlook is favorable, merchants encourage them to assume future obligations which they later are unable to meet because of some unforeseen event affecting their economic status. During a period of business depression however (strange as it seems to many), the instalment buyer is more

conservative and more careful of assuming obligations. As a result, repossessions and resultant losses are far less on instalment sales made in tough time than in the honey days of prosperity. For that reason, the instalment sale made today should be even more carefully checked than one made in 1932.

There are those who feel that the average person who buys on time will assume an obligation far beyond his means as long as he can get the credit. Generally speaking, this is false, as the records will show. There are some people, however, who over-estimate their future income or do not anticipate an unforeseen condition which might restrict their income. Present day finance plans have been revised in order to better protect this class of purchaser and the dealers who sell them, from experiencing future losses. Short down payments and long terms are products of the recent depression and were originated only for the purpose of forestalling a buyers' strike during the period when budgets were lower and purchasers hesitant. Sales figures point strongly to the fact that the public today has no complex against going to market. Therefore, if we are to "fit the payments to the

SHORT down-payments and long terms are products of the depression and were originated only for the purpose of forestalling a buyer's strike when budgets were lower and purchasers hesitant.

POPULARITY of limited recourse plans is proof that dealers have less confidence in the purchaser's ability to pay than do finance companies and their insurance underwriters.

INCOMES of all classes of purchasers have increased in far greater proportion during the past two years than corresponding increase in down payments and monthly payments recommended.

DURING a period of business depression the instalment buyer is more careful of assuming obligations and finance company figures show that repossessions are less than in normal times.

buyer's purse," the slight increase in down payments and monthly instalments now required is certainly in keeping with this program.

The large majority of radio dealers appear to welcome a return to more conservative terms because they realize that obsolescence is a factor to consider in financing radios on long terms. Radios are being constantly improved and changes in yearly models increase the hazard of financing present day models on long terms. Even though television is in its swaddling clothes and dealers realize that it will be some time before it goes to market, they would rather contemplate its future profit possibilities than to be in constant fear that this new arrival will catch them holding a big bag of long term instalment contracts endorsed with recourse.

Most of the present day radio dealers were selling radios back in the late 20's and early 30's and their memories are not too short to recall that era of repossession and its attendant headaches. Many radio salesmen and servicemen are today working for dealers who sold less, but earned more than they did during that period.

The popularity of the so-called Limited Liability or Limited Recourse finance plans during the past year is convincing proof that most radio dealers had less confidence in the purchaser's future ability to pay than did the finance companies themselves or their insurance underwriters. Now with his banker, his finance company, his manufacturer and his distributor urging larger down payments and shorter terms the retailer finds himself in the

rather unique position of having everyone agree with him for once on a merchandising policy. The old theme song of instalment selling "A dollar down, a dollar the rest of your life" has been supplanted by a revival of that old number entitled "Will you love me in December as you did in May"!

In line with the trend towards shorter terms, dealers and salesmen are hearing this frequent admonition from all sides, "Don't sell terms—sell radios." We suggest that this slogan be changed to "Don't sell *long* terms—but sell radios." "Terms" are here to stay and for very good reasons. As long as *price* is a principal factor considered by the prospective radio buyer, time payments are necessary to minimize this greatest hurdle—this last step—to a sale. When the prospect cools off at the mention of the cash price of the set, he is comparing this cash price with his present cash on hand, for which he has a thousand other uses. On the other hand, when the salesman shows him the relatively small monthly cash outlay required on a time payment plan the buyer mentally compares this figure with his monthly income.

The *cost* of the radio on a budget plan is greater than the *price* of the radio for cash, but not to the time buyer's viewpoint. He knows that

(Please turn to page 76)



T. O. McDAVID

RECIPE for



USE THE USER TO OBTAIN NEW LEADS

By
Laurence
Wray

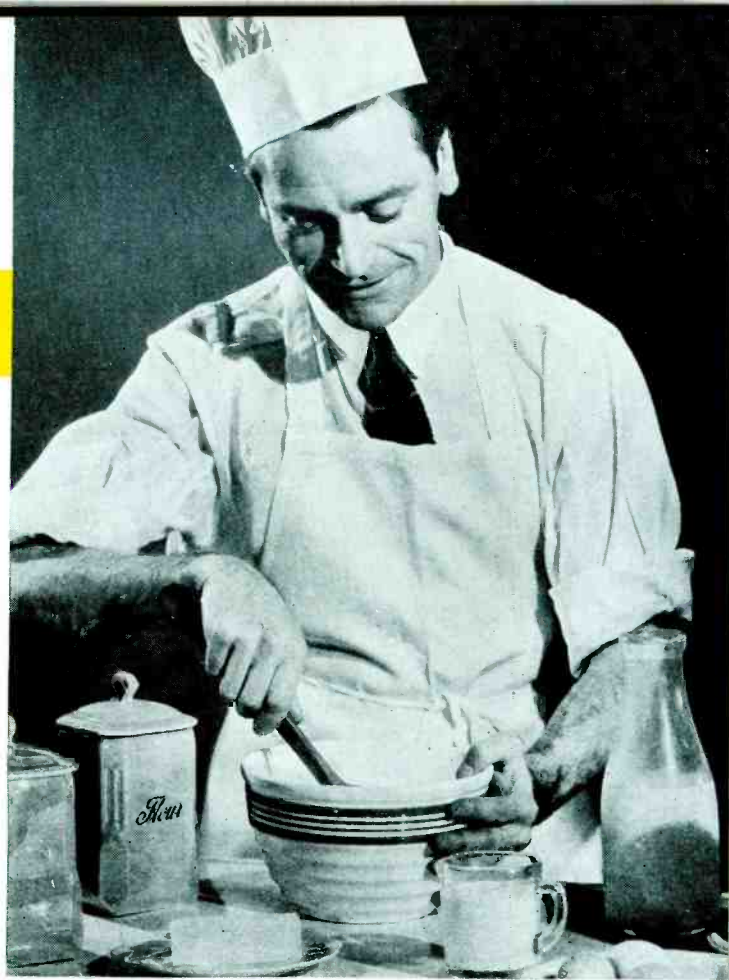

"REFRIGERATORS? Why bother me about that? Listen, I got plenty to worry about. I'm up to my ears right now in the radio business."

"Is it good? Sure it's good. Why look at this set here—you press a button, you got a station, you press another button you got Paris. You don't want Paris? Okey, then you got Italy where Mussolini hangs out. The dial leans backward like a debutante with two drinks—no scrunch, no squinch, no ginch. . ."

The salesman thought better of poking the dealer in the nose and poked him in the ribs instead.

"And what are you going to do after the holiday season is over", he asked. "Wouldn't you like to keep busy on another money-maker?"

"Refrigerators?"

"Sure. Refrigerators."

"Well, I tell you. If I get to thinking about refrigerators I can do it in the spring as well as now. That's when the refrigerator season starts, anyway. That's when the new models come out and I'll have more time to go over the situation."

"But the refrigerator manufacturers are all announcing their new models this fall", the salesman

pointed out. "Spring announcements are old stuff, now. If you want to be in a position to cash in on next year's refrigerator business, the time to start thinking about it is right now. Right now you can take your pick of the good ones. Right now you can start lining up some of your present customer list for spring signing."

"But I'm a radio man", the other said weakly. "I don't know anything about the refrigerator business."

"Joe Doakes down the street didn't either," the salesman said, "But he's selling refrigerators."

"Yeah, that's right, come to think of it," the dealer said, scratching his chin. "And the guy hasn't even got as good a store as I have. The only way he sells anything is by chiseling on prices."

He thoughtfully removed a large "Marked Down" sign from a radio set and said:

"All right, you tell me. What do I have to do to sell refrigerators? What has Joe Doakes got that I haven't got?"

* * *

That was all the man was waiting for and because you are probably getting just as tired of this conversation stuff as we are, we'll lay it right out, short and sweet in the King's English. And we might as well add that the following applies just as

much to radio dealers already selling electric refrigerators as to those who have not yet taken on a line. It's merely a recipe for successful refrigerator selling.

The Essentials

In order to avoid taking anything for granted, let's review the first three essentials:

1. A store that in appearance is fully equal to, and perhaps better, than the stores in his neighborhood. That means clean, attractive and inviting; properly identified with the dealer's name and business on the outside.

2. A location that is in a shopping or trading area.



TIE IN WITH LOCAL COOKING SCHOOLS

Selling REFRIGERATION

3. Regardless of what merchandise is handled, that a good display be maintained at all times—both in the windows and on the floor.

Given those things, the secondary essentials to a successful merchandising operation—sales training, advertising, outside selling, follow-up, using-the user, financing, shows and what have you—will follow in the degree to which the dealer is willing to invest time and money to get results.

A recent survey of 160 dealers making a success of refrigerator



TRY GIFT GADGETS FOR OPENING DOORS

merchandising showed that electrical stores, contractors, music stores, hardware, utility, furniture, sporting goods, automobile, grocery, battery shops, department stores and—of course—radio dealers, were all represented. There were even a couple of undertakers among the lot. In other words, the type of business from which the refrigerator operation stemmed was relatively unimportant. Of great importance, however, were the methods used to hustle boxes into customer's homes.

Let's review some of these for a starter:

Two-thirds of all dealers had handled one line for five years or more—they had concentrated their efforts behind that single line.



FOLLOW UP WITH LIBERAL TELEPHONING

Ninety-five per cent of the dealers used all or part of the sales and promotional help supplied by the manufacturer; 92 per cent of them are consistent newspaper advertisers; 59 per cent use outdoor advertising—posters, bulletins, etc.; 32 per cent use local radio advertising; and more than 70 per cent use more than one kind of local advertising supplied by the manufacturer.

Sales Training

In the refrigerator business, sales training is of even greater importance than in the radio business. The public, by and large, are aware and receptive to the idea of radio entertainment.

Style, competitive advantages of various sets and price are the factors having greater bearing on eventual sale than education for the need. The same is not true of the refrigerator business. It is becoming more so, what with sales of 2,000,000 units a year and a present saturation of close to 45 per cent, but still the need for food preservation, the economies effected over the old ice method, the convenience and other advantages have to be sold. That means trained men and the proof that successful refrigerator merchants are aware of this need is shown in the figure of 98 per cent of those interviewed who declared that "sales training is absolutely essential to refrigerator retailing."

There are other methods of sales training, of course, besides the direct

one of schooling men on selling technique. Regular sales meetings are held by 88 per cent of these dealers, sales stimulation which includes sales training material is utilized by another 79 per cent while 24 per cent use sales literature, manuals, bulletins, films and the like.

Display and Still More Display

Hardly a dealer among the crack-jack refrigerator men interviewed but what believes in display, demonstrations or dramatic presentations of one kind or another. Manufacturers' window display material, which is uniformly good, gets a play from 98 per cent of the dealers, 10 per cent of whom use it as is; 94 per cent use display material inside the store and 98 per cent have some form of demonstration equipment. Action displays such as have been described and illustrated in *Radio Retailing* get a play from about 30 per cent of the dealers.

Using the user—following up the owner—seems to be the favorite method of prospect-getting. Some 48 per cent of refrigerator dealers



COVER YOUR NEIGHBORHOOD BY MAIL

interviewed favored this method over all others. Reasons are not hard to find: Inasmuch as the refrigerator idea has to be sold to the public before a piece of merchandise, the buyer is generally anxious to sell the idea to her neighbors and friends, too—a human trait that stands the smart dealer and salesman in good

(Continued on page 76)

NO

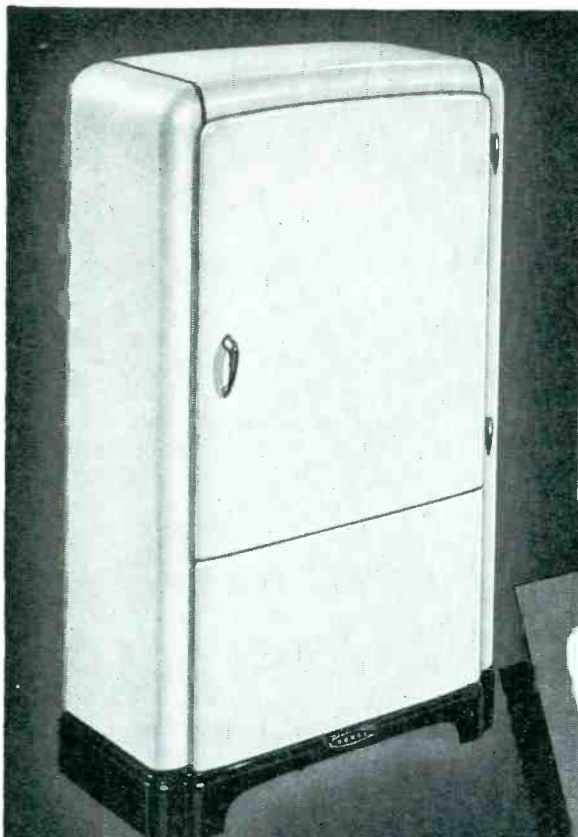

Rollator Refrigeration

Rollator Refrigeration protected by 10-Year Warranty on the three-moving-parts Rollator-Compression Unit.

OFFERS YOU

Greater Opportunities

EVERY MONTH OF THE YEAR



Concentrator Gas + Electric Ranges

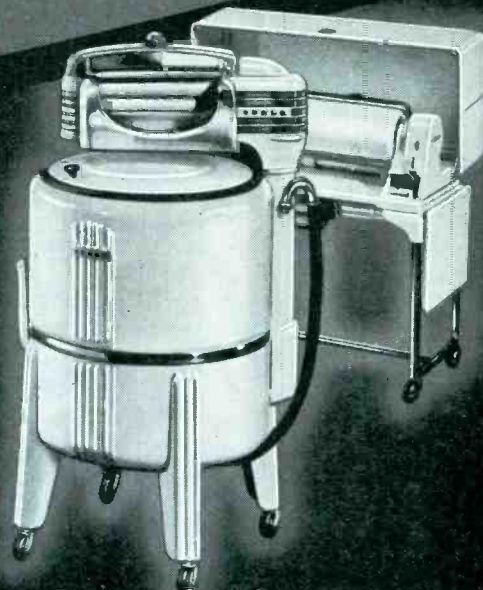

Autobuilt Washers and Duotrol Ironers

NORGE

PRODUCT!

★ Every survey of consumer preference proves that Norge appliances lead in customer satisfaction. And Norge consistently ranks among the first three in public acceptance. The 1938 line is the greatest in Norge history. A new dramatic sales approach will be pushed in all advertising, promotion and store display. Exclusive features in the new Norge line give you the most convincing show room demonstrations you have ever seen.

PROFIT!

★ Every month is a profit month with Norge Master Merchants. There is always sales activity in the Norge line of Rollator Refrigerators, Concentrator Gas and Electric Ranges, Autobuilt Washers, Duotrol Ironers and package heating and commercial equipment. Get full details now about the smashing new Norge advertising and sales promotion program of *simplified visual selling*, that gives the dealer the break he's been looking for.

TURNOVER!

★ High product turnover and liberal finance plans keep your capital working for you all the time. Low dealer and salesman turnover proves that men have found it pays to sell Norge and *stick to Norge*. The Norge dealer whose picture appears on this page offers a typical example of the opportunities a Norge franchise offers—a franchise more valuable today than ever before! Get the facts about Norge without delay.

NORGE DIVISION Borg-Warner Corporation, Detroit, Michigan

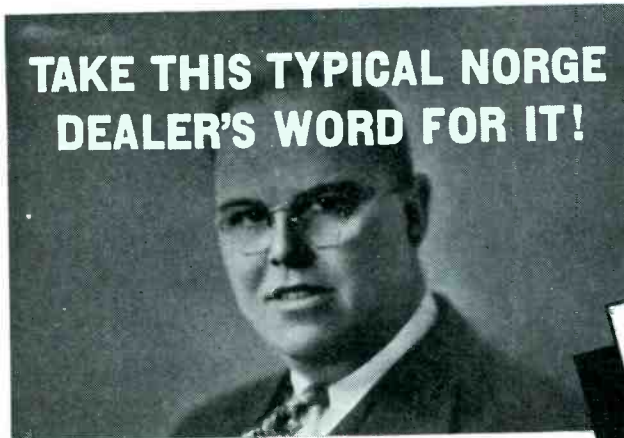

TAKE THIS TYPICAL NORGE DEALER'S WORD FOR IT!

"There are no off months in the appliance business for an exclusive Norge Master Merchant. By concentrating my entire efforts on the complete Norge line of appliances I actually turned my inventory twelve times in that many months, and was able to show better than a 10% net profit on my year's operation." NAME ON REQUEST)



FREE! TO APPLIANCE DEALERS!

A full volume on appliance selling and promotion. One of the greatest dealer helps ever produced. Describes a complete plan of store operation. Tells how to get the most out of advertising and sales promotion. Reveals for the first time a new tested method of visual selling. No matter what products you sell, this book will show you how to make more money in the appliance business.

NORGE DIVISION Borg-Warner Corporation,
654 East Woodbridge Street, Detroit, Michigan.

I would like to receive a copy of your new book for appliance dealers.

NAME
ADDRESS
CITY STATE TP-1

MAIL TODAY!



ANY FAMILY ANYWHERE CAN ENJOY THIS FAMOUS SILENT REFRIGERATOR . . . RUNS ON GAS, BOTTLED GAS, OR KEROSENE

CITY . . . TOWN . . . FARM DISTRICT. It makes no difference where you sell. You can make good money with Servel Electrolux. For this popular refrigerator can be operated with any one of three fuels—gas, kerosene, or bottled gas—and thus can be used in any home.

Best of all, Servel Electrolux gives you a sales story that no competitor can match. Known from coast to coast as the refrigerator that has no moving parts in its freezing system, Servel Electrolux is the one refrigerator that offers your customer permanent silence and a low running cost that *stays* low, year after year.

During 1937, Servel Electrolux is staging the great-

est advertising campaign in its history. Since last winter, more than 32,000,000 people a month have been reading about this different refrigerator in leading magazines . . . have been hearing about it by way of radio's greatest dramatic show, "The March of Time." Those millions of families *want* Servel Electrolux. Servel, Inc., Servel Electrolux Sales Division, Evansville, Indiana.

SERVEL ELECTROLUX
THE *Gas* REFRIGERATOR

THESE EXCLUSIVE SELLING POINTS ARE YOUR STAR SALESMEN

- Permanent Silence
- Lasting Efficiency
- Finest Modern Beauty
- No Moving Parts To Wear
- Continued Low Running Cost
- Every Worthwhile Convenience

FINISHED, IT FEATURES ALL FOUR—
 Motion . . . promotion for automatic tuning
 . . . emotion at Christmas . . . topknotch
 winter broadcasts

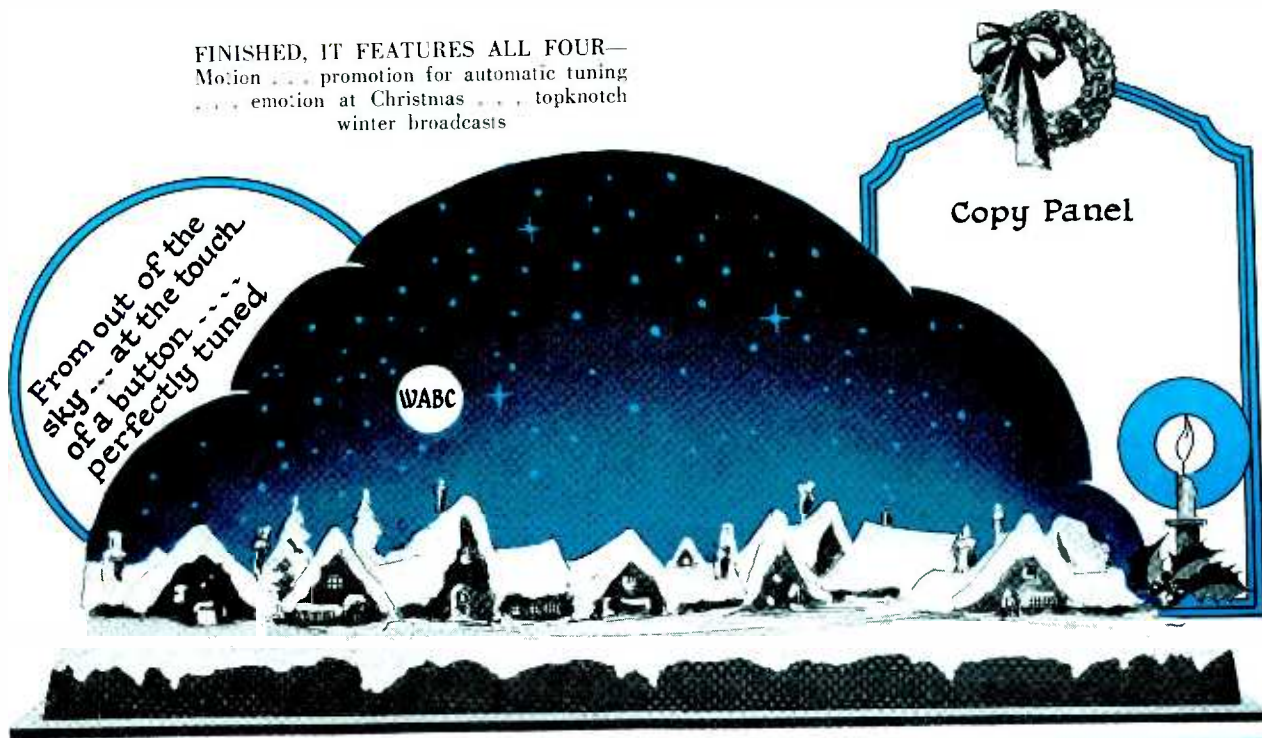

Holiday Window

By I. L. Cochrane

ON page 29 of October *Radio Retailing* ("A Window That Won't Wear Out"), the construction of a display platform, flasher box and mechanism was described. Exactly the same basic outfit may be used, as promised last month, in the Christmas display described and illustrated here, this with the interests of the dealer who must watch the pennies and still appreciates the importance of effective windows in mind. Changes consist primarily of using different cardboard, altering decorative treatment.

Describing the action and appearance of the finished Christmas display as best we may in mere words, a starlit sky is set up as its principal element. At three second intervals seven leading station call-letters successively flash on and off in this sky. Snow-covered houses in the foreground give the display excellent emotional appeal. And the slogan . . . "From out of the sky . . . at the touch of a button . . . perfectly tuned" helps emphasize the theme.

Getting down to details . . . The central or sky section is made of heavy cardboard or wallboard, with seven circular holes cut to match the size of those in the flasher box. Then bleached theatrical gauze is glued over the holes in the sky section. Next, the surface of the sky is painted in flat white, several times around edges of holes, in fact, to hide the gauze glued to the wallboard. Then a

medium blue is airbrushed over the entire surface, including gauze.

Dennison Mfg. Co. makes an assortment of silver stars, costing a few cents, and sold wherever Christmas decorations are sold. Assorted sizes of these silver stars are pasted in to build up a night sky effect.

The side panels are show cards, and decorated in bright Christmas colors to form a colorful background for the blue sky. A length of plain green cardboard covers the bottom of the platform and is also extended around to the sides. Over that is draped a sheet of imitation snow, such as that made in sheets and balls by the Frostee Sno Ball Co., 1740 North Kolmar Ave., Chicago, and sold by display houses, some department stores and chain stores. Standing about nine inches back from the snowy edge is a cut-out row which forms a Christmas village, and the sky section is just far enough back of the village to allow a row of small white lamps in between. These lamps work on the

eighth flash of the flasher box, and lighten up the face of the sky.

Many variations are possible. For instance, you may prefer to substitute a large wreath for the circular show-card at the left. If so, place a strip of cardboard across its center, and let—
 (Please turn to page 76)



I. L. COCHRANE

Modern Appliances



Twelve different interior arrangements are possible in each of the 16 new models of the Norge Division, Borg-Warner Corp., Detroit, Mich.; the illustrated odor-proof evaporator (sealed front and back) keeps all foreign tastes and odors from the ice cubes

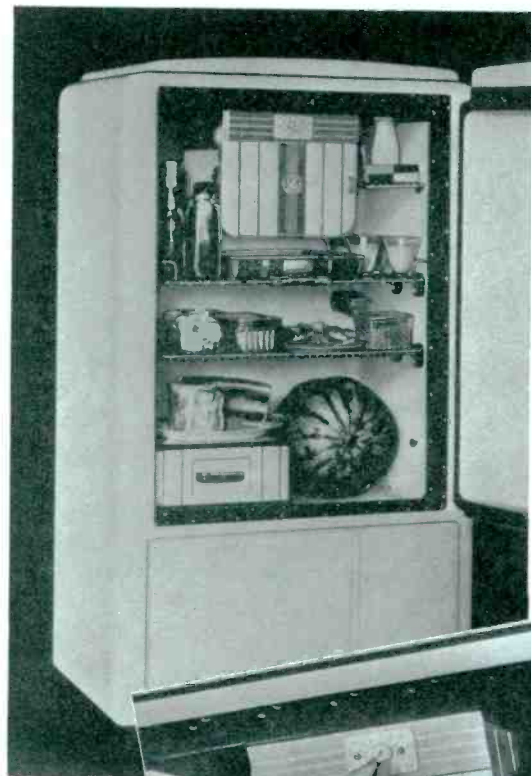

The one-button control on the new line of Triple Thrift refrigerators made by General Electric Co., Bridgeport, Conn., simplifies operation in that it controls freezing as well as defrosting; freezing continues during defrosting period

NORGE

GENERAL ELECTRIC



STEWART WARNER



The Sav-A-Step swinging basket, a feature of the 1938 refrigerator line of Stewart Warner Corp., Chicago, Ill., may be carried to the table while cooking; holds the foods most often used; turns back-shelf-space into front-shelf-space



HORTON

Kleenette is the new "personal" washer just brought out by the Horton Mfg. Co., Ft. Wayne, Ind.; designed to take care of daily laundings and the many "between-wash" jobs; especially designed for fine fabrics, sheer stockings and filmy under garments; fits right over the agitator shaft of any Horton washer back to 1928 models

Feature Convenience



The conveniently located temperature regulator to be found in 1938 refrigerators of the Westinghouse Elec. & Mfg. Co., Mansfield, Ohio, not only indicates the position of the control but also shows the temperature of the food compartment

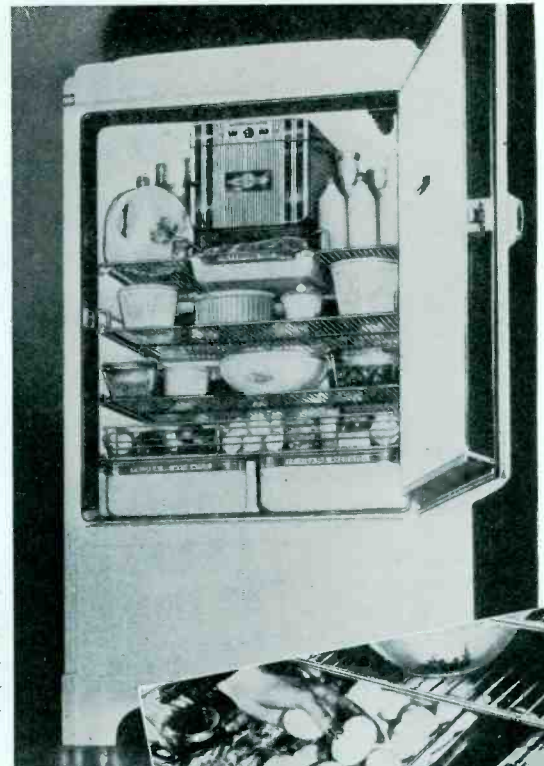

The special utility basket shown in the insert is a regular little department store in itself; sliding shelf brings all food into full view; the nine-way adjustable interior increases storage space; Frigidaire Corp., Dayton, Ohio

WESTINGHOUSE

FRIGIDAIRE

HOT POINT



The new Hotpoint Dorchester range of Edison General Electric Appliance Co., 5600 W. Taylor Ave., Chicago, Ill., is of the built-to-floor type with chromium trimmed lamp with tubular Lumiline bulb; shelf with condiment jars and Time Chime; three Hi-Speed Calrod units

To meet the trend toward functional styling, General Electric Co., Bridgeport, Conn., has brought out a complete line of washers for the planned laundry; all models are equipped with Activator, 12 1/2 in. high; 3 blades with 3 washing zones; 1/4 hp. motor free from radio interference

A square tube washer streamlined in the modern manner is announced by the Crosley Radio Corp., Cincinnati, Ohio; the large 23 gallon tube is enameled with white porcelain inside and out; agitator is of the removable invertible type that combines advantages of both "top" and "bottom" washing methods



GENERAL ELECTRIC



CROSLY

COPELAND



The announcement of a line of electric ranges by Copeland Refrigeration Corp., Detroit, Mich., widens its range of household appliances which, up to now, included refrigerators, washers and ironers; the range line is made up of 5 models, smart in appearance and compactly designed, as well as a portable electric cooker

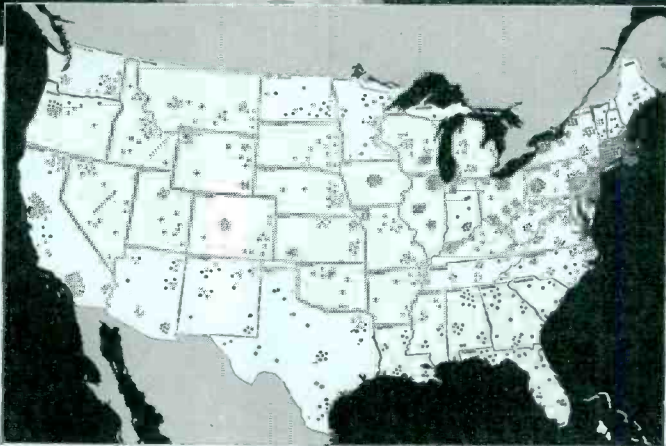
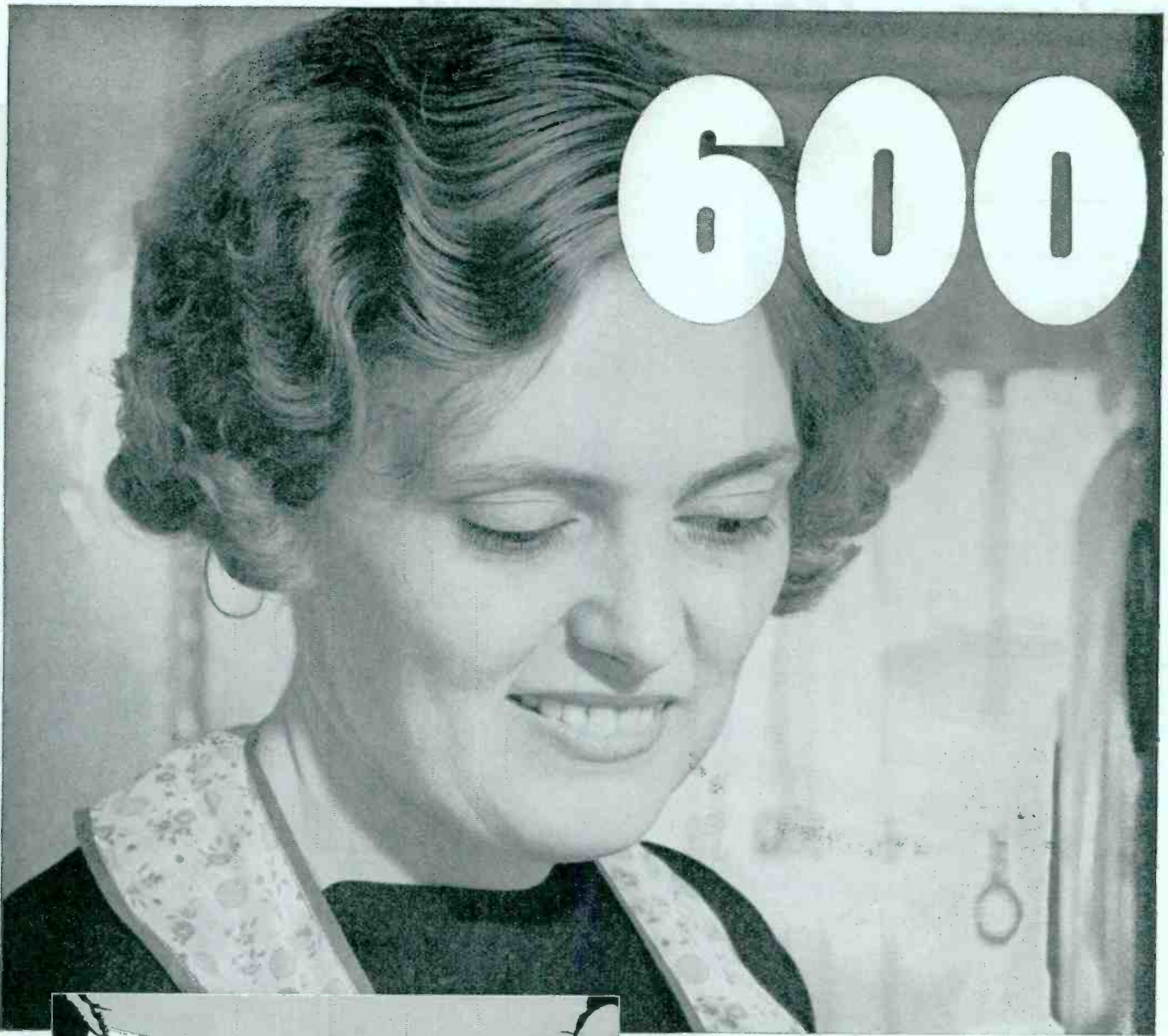

MEET MRS. ANNABEL ALQUEST, OF KANSAS CITY, MO.

She is typical of the 600 women who, during the past summer, tested 1938 Leonard Refrigerators in *their homes*. These 600 homes are located all over the United States—in every state of the Union.

The owners of these 600 Leonards kept accurate records of the performance of their refrigerators. Records of their operating cost—daily recordings of kitchen temperatures and temperatures inside the cabinets. Service calls were also carefully noted. These records, now in Detroit, prove two things—and prove them conclusively.

First the 1938 Leonards are more efficient, more economical to operate, more usable and convenient than ever before.

Second that they will reach dealers ready to perform 100 percent: that they will operate under any conditions in the homes of users anywhere. Truly the 1938 Leonard will be a "Tried and proven refrigerator." Six hundred women have given it their stamp of approval.

1938 LEONARD

LIKE HER

WROTE THE 1938 LEONARD STORY!

AND WE DO NOT BELIEVE THAT ANY MANUFACTURER
IN THE REFRIGERATION FIELD HAS EVER HAD
A SELLING STORY LIKE THIS TO TELL!

It's about the 1938 Leonard—and it comes from forty-eight states throughout the Union—from 600 level-headed women in 600 typical American homes.

One of these 600 women is Mrs. Annabel Alquest of Kansas City, Missouri. Multiply what she told us about this marvelous new Leonard by the six hundred dots on the map and you'll get some idea of the "performance" story that Leonard will have in 1938.

And get this—you dealers who want the hottest, surest-fire line of refrigerators to sell! This 1938 Leonard, while it will be new to the field, is not new to us. It is the product of ten years of engineering research and laboratory tests. We believed it to be 100 percent right when we put it on the production line in the spring of 1937.

Now—as the result of a summer of tests in 600 actual homes—we know that this 1938

Leonard is the most efficient, the most powerful and the most economical refrigerator that has ever been built. And that's a statement that packs real dynamite.

When you see the new Leonard you are going to have to admit that it's also the most beautiful, the most convenient and the most completely usable refrigerator you've ever laid your eyes on.

Leonard's 57 years of refrigerator building experience are summed up in this wonderful new product—and 600 women in 48 states have already given it their enthusiastic endorsement.

That's why we say that no electric refrigerator manufacturer has ever had a story like this to tell to a field organization—and no field organization has ever had such a selling story to tell to prospects.

LEONARD—Division of Nash-Kelvinator Corporation, Detroit, Michigan

"Biggest Bargain in Refrigeration Today"

Look out for "STEP-FATHER POWER"

In your business, two factors will make you or break you. Number one is customer satisfaction. They've got to like you well enough to *come back for more*.

Number two is profits. If you don't make money *consistently*, you can't last.

That's why we say, "Look out for 'Step-Father Power'." The "Eveready" "Air Cell" "A" battery is the *daddy* of two-volt radio. Dry "A" batteries and elaborate, troublesome charging devices are *step-fathers*.

When you sell "Eveready" "Air Cell" batteries you sell *steady voltage*, no costly, bothersome recharging, and long life...1,000 hours of *guaranteed* satisfaction.

The "Eveready" "Air Cell" "A" battery is clearly the right thing for the dealer who intends to stay in business, with *guaranteed* service to every user, a real profit on every sale.



"EVEREADY" "AIR CELL" RESISTOR WIDENS YOUR MARKET



Every true "Air Cell" receiver, no matter who makes it, is approved by National Carbon Company, Inc., and is ready to function on "Air Cell" "A" power without the addition of resistors.

All other 2-volt receivers may be quickly and easily adapted to the economical *level power* of the "Air Cell" battery by adding an "Eveready" fixed resistor of the proper value. Through this simple operation, the set owner is freed from

tinkering with hand-operated resistors, from short-lived ballast tubes and from the excessive power-waste of dry "A" batteries, the nuisance and expense of storage batteries, chargers, etc.

Get a card of these "Eveready" "Air Cell" Resistors at once. Always keep them on hand. Note the five different resistances on each card so you need buy only one to take care of sets from 480 to 740 milliamperes drain.

NATIONAL CARBON COMPANY, INC.

GENERAL OFFICES: New York, N. Y. BRANCHES: Chicago, San Francisco

Unit of Union Carbide  and Carbon Corporation

The words "Eveready" and "Air Cell" are trade-marks of National Carbon Co., Inc.

REMINISCENT of the deaf-mute "finger language" used for rapid communication between traders in the street and stock-brokers high up in office building windows back in the days when the New York Curb Exchange actually functioned out in the open air is the wigwag technique evolved by NBC's ace football reporter, Bill Stern.

A "spotter", out on the field in touch with the umpire, signals the reason for penalties. Bill watches his hands, relays this information to the waiting radio audience.

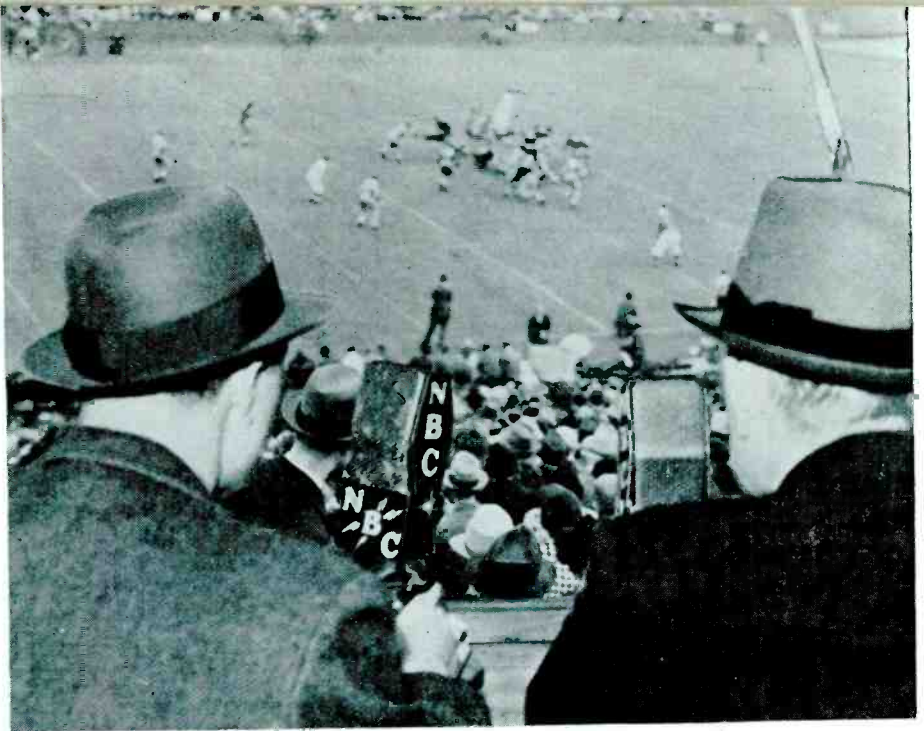

HANDS ACROSS THE GRIDIRON

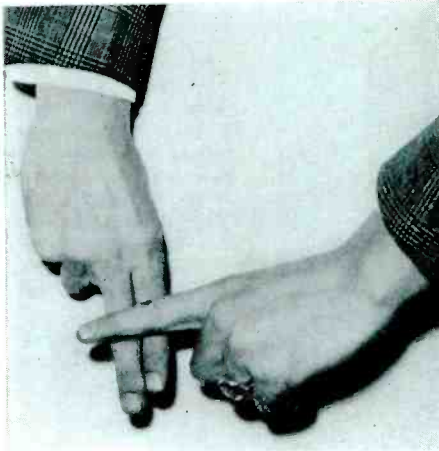
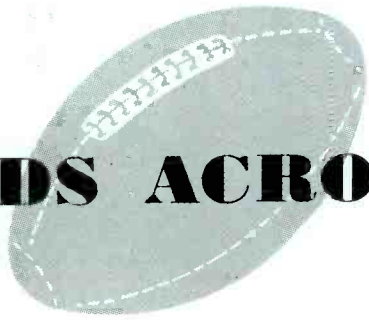

Holding

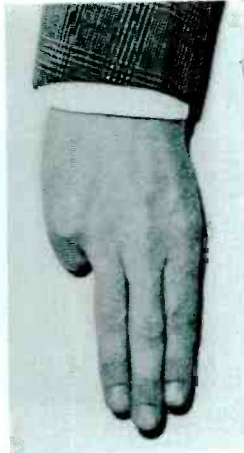

Piling on



Too many time-outs

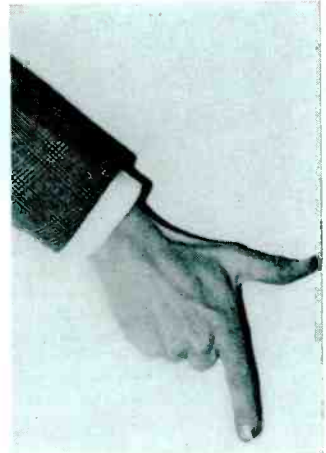

Roughing kicker

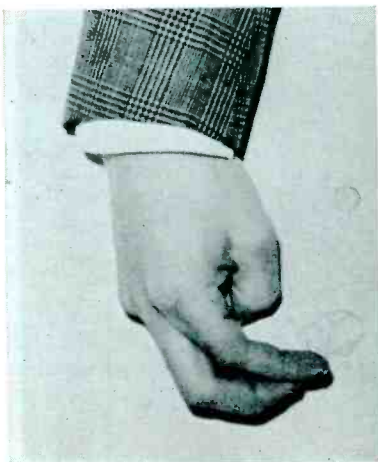

Crawling

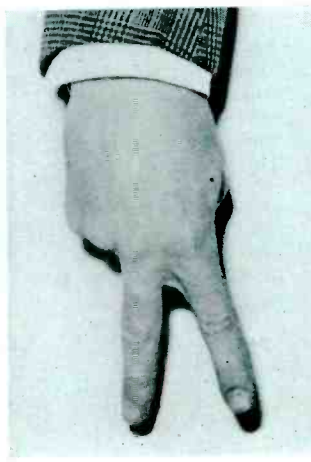

Interference on pass

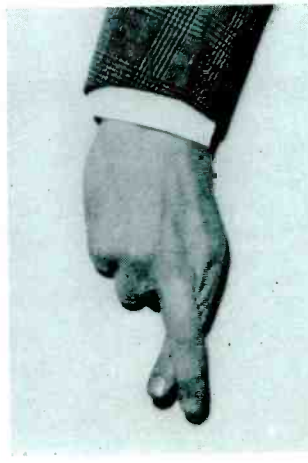

Unnecessary roughness

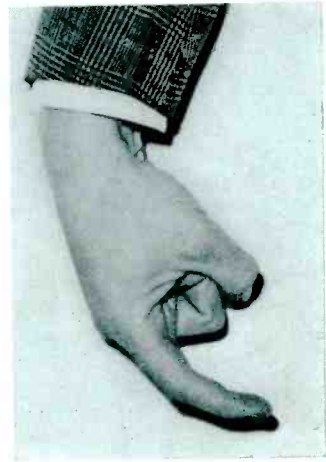

Backfield in motion

Preview of New



MAJESTIC

This modern chairside adaptation, Model 672, has cellarette compartment furnished with ice bucket and glassware; cabinet is made of fine matched walnut woods with sliding top that covers radio and acts as serving tray; top is finished in alcohol-proof lacquer; 6 tube set with Telematic automatic tuning; chairside radio and the Plaskon compact pictured below are made by the Majestic Radio & Tel. Co., 2600 W. 50th St., Chicago

The 5 tube ivory Plaskon compact (right) is also available in ebony and walnut molded Bakelite; tuning range in 2 bands covers 540-1750 kc. and 2.2-7.2 meg.; 5 1/2 in. electro-dynamic speaker; cabinet measures 8 x 12 x 7 3/8 in.

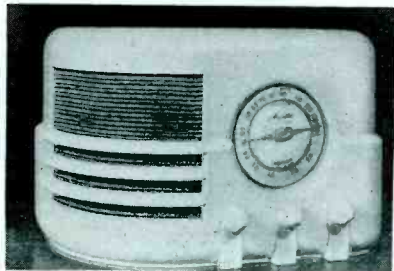

MAJESTIC

There are no buttons to push and no dials to spin with the Flash-O-Matic automatic tuning used in Model 358 of the Fada Radio & Elec. Co., Long Island City, N. Y.; a single knob gives 6 different stations in a split second; 5 tube chassis for ac operation; 6 tubes for ac-dc; \$49.95

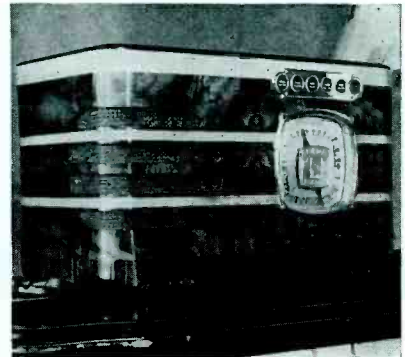

FADA



WILCOX GAY

An inclined front panel, automatic telephone type dial, vernier touch tuning, large straight line refracting glass scale in colors—all are included to facilitate accurate and easy tuning; this Wilcox-Gay (Charlotte, Mich.) Model A-37 has large acoustically corrected dynamic speaker; 540 kc to 20.5 mc

Typical of the new line of DeWald sets—starting at \$16.75 and covering the entire popular price range with its 25 models—is the illustrated 1200, a 12 tube superhet with multiple band reception; all cabinets styled with an eye to color harmony; Pierce-Airo, Inc., 510 Sixth Ave., New York City



PIERCE-AIRO

Radio Merchandise

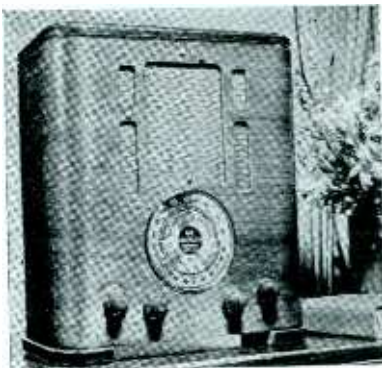

CROSLY

For 6 v. storage battery or 110 v. ac operation, Crosley Radio Corp., Cincinnati, Ohio, offers Model B-667A with edge lighted, gold reflector type Mirrodial; 530-1850 and 1900-22000 kc.; 6 tubes; cabinet of sliced walnut; one of seven new models—five table sets and two consoles

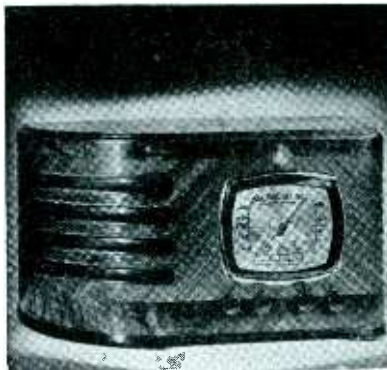

EMERSON

A tapered end table radio, set on an ebonized base, is a part of the line of the Emerson Radio and Phonograph Co., 111 Eighth Ave., New York City; it is a 6 tube receiver with Miracle Tone Chamber; tuning range, 16-54 and 172-555 meters; avc; Emerson foreign tuning principle; 6 1/2 in. speaker

The "Super-Pro", formerly available only in table cabinet or in rack and panel style, may now be obtained from the Hammarlund Mfg. Co. Inc., 424 W. 33rd St., New York City, in the illustrated console; a bass reflex sealed sound chamber and special 15 in. speaker add materially to the acoustical performance

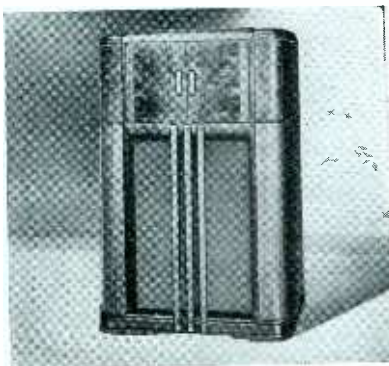

HAMMARLUND

A unique example of the practical in end table design, this chairside Model 6A1 of the Galvin Mfg. Co., 4545 W. Augusta Blvd., Chicago, Ill., has a 6 tube, 2 band radio with electric eye tuning; Golden dial; tone-voice control; 540-1750 and 5650-18,000 kc.; 59.95



GALVIN



FREED

A smartly styled walnut veneer and inlay cabinet houses the latest addition to the line of the Freed Mfg. Co. Inc., 44 W. 18th St., New York City; known as Model 29-D it uses 11 tubes, has electric eye tuning and covers standard American and foreign shortwave bands; ac-dc; \$45.95

PREVUE OF NEW RADIO MERCHANDISE



WESTINGHOUSE

An armchair radio with slanted dial panel is offered by Merchandising Headquarters, Westinghouse Radio, 150 Varick St., New York City; it is a 7 tube receiver with Precision eye; 540-18,000 kc.; the vertical grille pilasters add a distinctive note to the cabinet

Dials and tuning knobs have been completely eliminated in this 6 tube table of the Howard Radio Co., 1731 Belmont Ave., Chicago, Ill.; the push button automatic tuning may be instantly set for 8 stations and the selection changed at will; Magic Eye; two-position cabinet may be used as top-tuner or horizontal

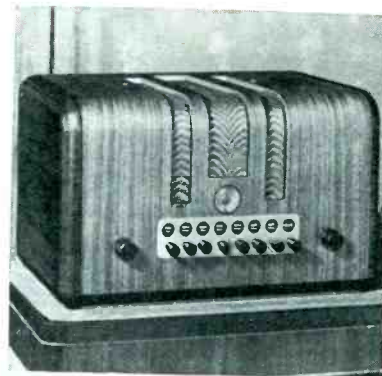

HOWARD



CLARION

Electric flash tuning with six Magic buttons is incorporated in Model 70X table set just placed on the market by Clarion Corp., 888 Pure Oil Bldg., Chicago, Ill.; no motor or mechanism to get out of order; all adjustments are made by hand with selector knob; \$29.95

The "Rura-Lectra", a set especially designed for rural families living in areas where electric power is a possibility but not yet an actuality, has been developed by RCA Mfg. Co., Camden, N. J.; operates on 110 v. ac or a 6 v. storage battery; "distance booster circuit"; \$44.95



RCA

Latest type beam power tubes are used in the Model 835 35-52 watt amplifier announced by the Operadio Mfg. Co., St. Charles, Ill.; three input channels; electronically mixes two microphones or two microphones and phonograph; new non-resonant equalizer used as tone balancer for both high and low frequencies

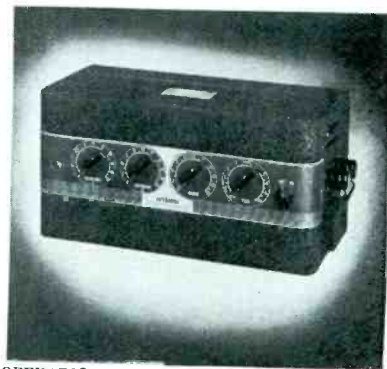

OPERADIO

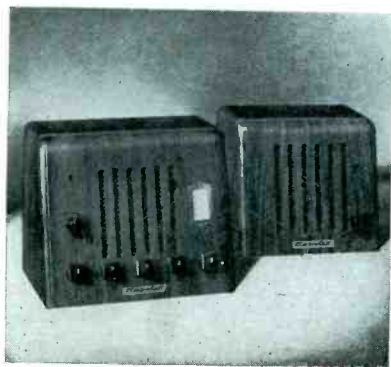

ELECTRO-CALL

A line of Electro-Call intercommunication systems, entirely different from previous models, has been developed by United Scientific Labs., 510 Sixth Ave., New York City; every Electro-Call is two-way, selective and intercommunicating; three distinct systems available—two-way, five-way and six-way

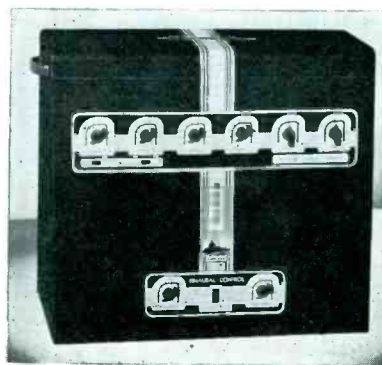

BOGEN

Binaural amplification, now available in the CX70 amplifier of David Bogen Co. Inc., 663 Broadway, New York City, creates what is known as auditory perspective — that intangible tone difference between listening to the original rendition to its reproduction; electronic tone correction also included; \$169.50

RCA VICTOR DEALERS

Move Ahead On All Fronts!

An illustration of four soldiers in military uniforms marching forward. They are carrying a large, rectangular sign on their shoulders. The sign is tilted and features the RCA logo at the top left. Below the logo, the text reads "COMMERCIAL SOUND • RECORD PLAYERS" along the top edge, "RADIO SETS" in large, bold letters in the center, and "TUBES • PARTS" along the bottom edge. The soldiers are smiling and appear energetic. The background is a simple, stylized landscape with some foliage.

**ONLY COMPLETE
LINE IN THE
BUSINESS**

**PROFITS... 12
MONTHS A YEAR**

**JOIN THIS POWERFUL
ARMY AND MAKE
MORE MONEY!**

**"RCA ALL THE WAY"
MEANS
"NEVER A SLACK SEASON"**

IT'S YEAR-ROUND PROFITS WHEN YOU HANDLE RCA!..

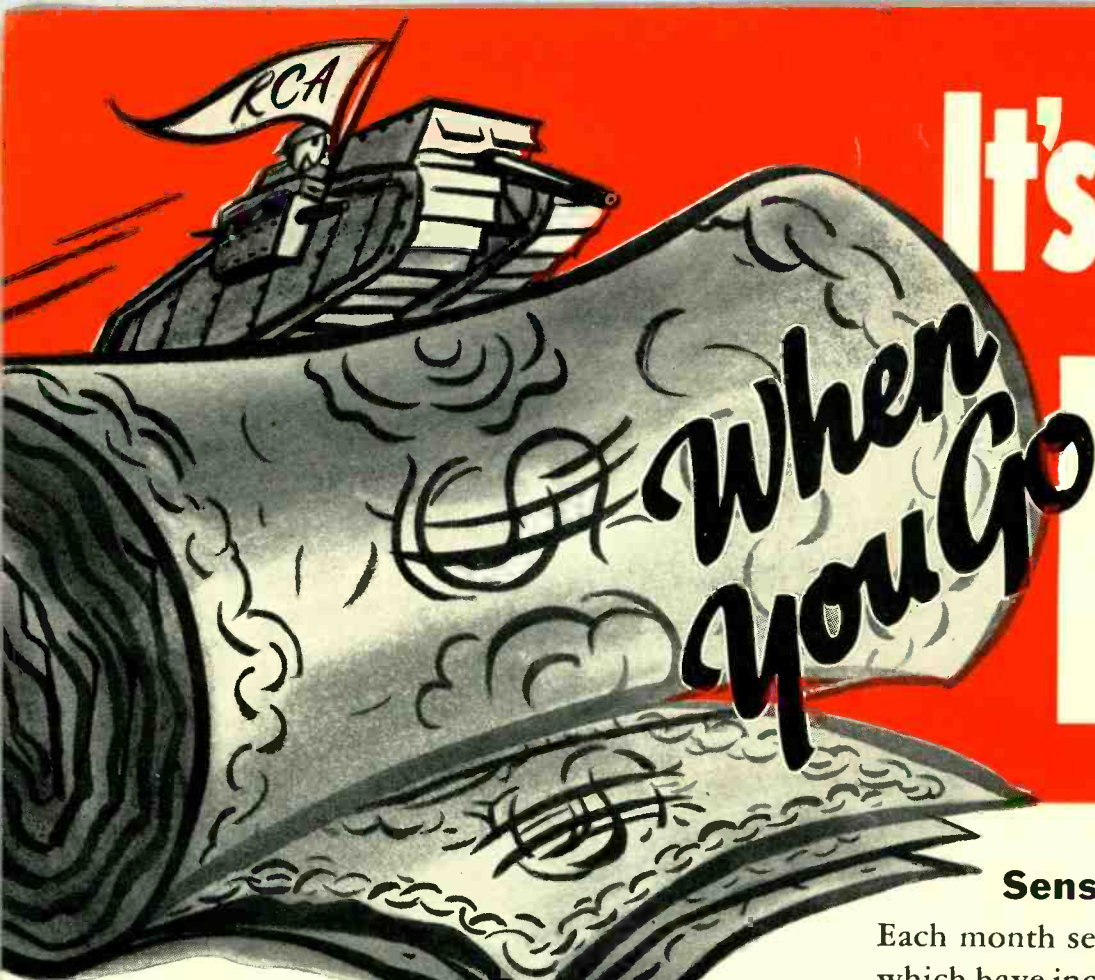

It's Money in RCA

Here's Why!

1. Only RCA offers you a complete line of radio and sound products—every one a sensational success.

Dealers say it pays them **BIG PROFITS** to go "RCA All The Way." For only RCA offers them a complete line of radio and sound products. Dealers find that by selling *all* the products of RCA, they get a steady year 'round business... no seasonal declines... which often occur when dealers carry one product only. RCA makes *all* the important radio and sound items a retailer needs... all bear one name, RCA... all are packed with features that make selling easy... each a leader in its field. The following facts tell an impressive story of why it will pay *you* to go "RCA All The Way!"

RCA Victor Electric Tuning sets terrific sales pace

In a survey of 15,000 dealers, Electric Tuning was voted the year's greatest selling feature. It has sold radio after radio, smashing all previous sales records. Each sale means \$60 or more profit for you.

Sensational Victor Record gain

Each month sets a new high mark in record sales, which have increased 575% in less than four years. *Proof* that people are *hungry* for music. If you're not selling Victor Records you're missing tremendous profits.

RCA Victor Combination and Record Player sales shoot up

Everywhere, sales of RCA Victor Phonograph-Radio Combinations and Record Players mount higher and higher each day. Every sale means a double profit—on Instruments and on Records.

RCA Tubes unquestioned sales leader

300,000,000 of them have been sold—*proof* of their public acceptance. Proof, too, of the ready market for their sale!

RCA Commercial Sound Equipment sets new high in installations

Here's a business that is on the up-swing—and traveling fast. RCA makes equipment to cover every phase of commercial sound. Ask your distributor for the latest RCA Sound Catalogue.

RCA Parts break all sales records

Never in RCA history have parts sales been so

Your Pockets All Year Round ALL THE WAY

high! Genuine RCA replacement parts, accessories and test equipment mean extra money for you. Ask your distributor for the latest Parts Catalogue.

2. Only RCA offers you products of the world's greatest radio and sound organization.

No company in radio has a background of achievement that even closely approaches RCA's! Only RCA is engaged in every phase of radio and sound. Through the National Broadcasting Company, RCA creates and broadcasts the majority of network programs. Through Victor, RCA has the benefit of 39 years' leadership in sound reproduction. And RCA engineers, NBC broadcast skill, Victor mastery of tone are responsible for the excellent quality of every RCA product. This means every RCA dealer can offer his customers the finest in radio and sound.

3. Products consistently advertised and promoted for 39 years.

Every year RCA spends millions of dollars in magazines, newspapers, and on radio programs to promote the sale of its products. And that advertising makes sales for RCA dealers. When you go "RCA All The Way," *you can be sure* that every product is backed by advertising.

4. RCA offers you the greatest name in radio.

RCA's unmatched experience in all branches of radio . . . its outstanding accomplishments . . . its splendid products—all have earned for the RCA trade-mark unequalled fame! The buying public *asks* for RCA Products. And your association with RCA stamps you as a reliable retailer. That, too, means more money for you.

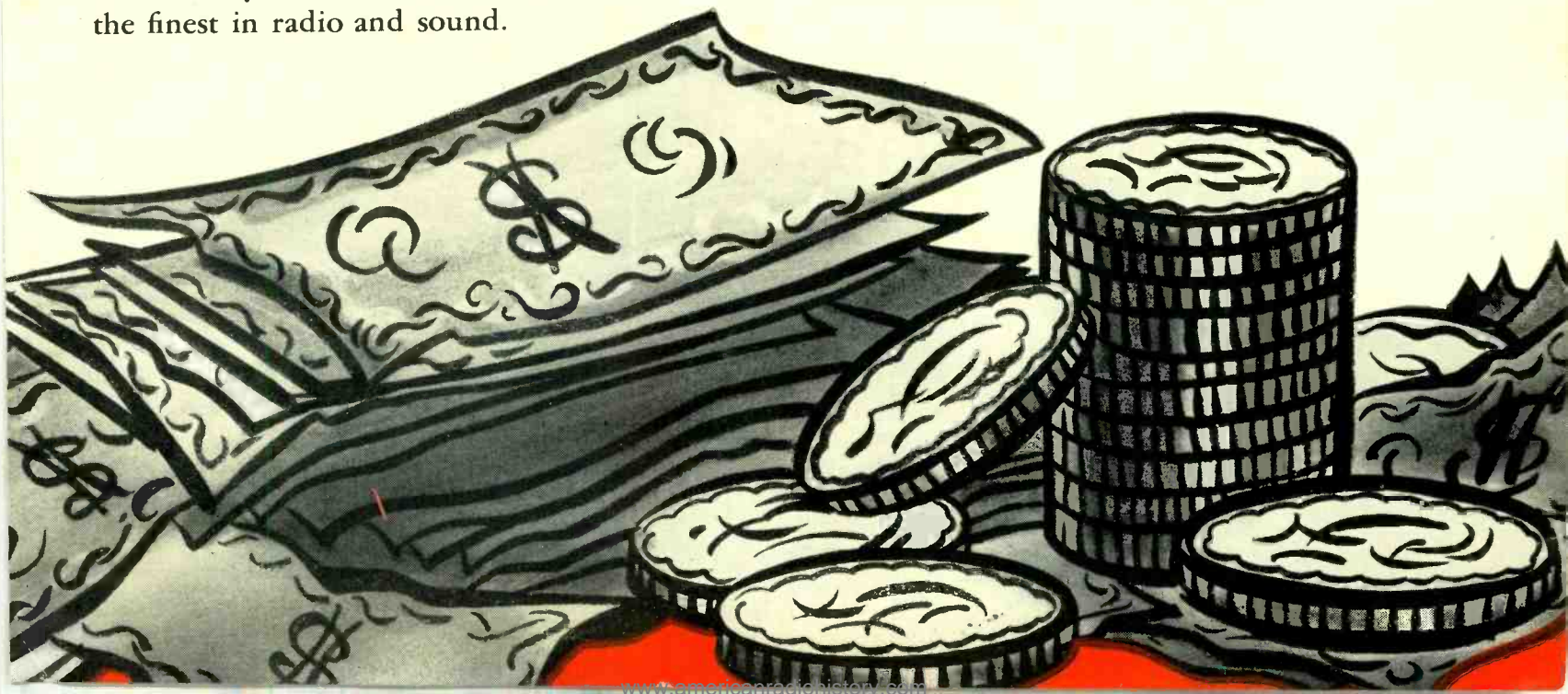

MEMBERS OF THE RCA PROFIT ARMY..

Men like "JOIN UP!"
You SAY

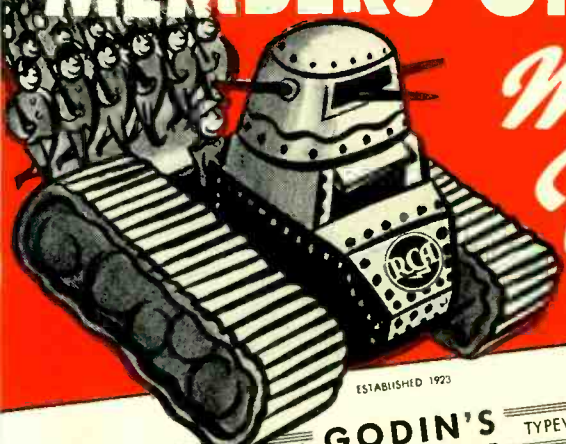

ESTABLISHED 1923
GODIN'S
 CASH or CREDIT
 562 FIFTH AVENUE
 BETWEEN 15th AND 16th STREETS
 BROOKLYN, NEW YORK

Watches - Jewels - Radios
 TYPEWRITERS - ELECTRICAL APPLIANCES
 FINE WATCH AND JEWELRY REPAIRING

October 29, 1937.

RCA Manufacturing Co.,
 Camden, N.J.

Dear Sirs:
 I have been an exclusive RCA Victor dealer for 16 months selling RCA's entire line of products in the field of radio. I send you this letter because I think you deserve to know what a profitable venture going "RCA all the way" has been for me.

Before I took on all the RCA products I did a pretty good business around South Brooklyn selling radios. But since I have standardized on one name and carry a line that is complete in every way, my radio business has not only skyrocketed, but I have felt a general improvement in other lines that I carry. And best of all my profits are consistent - monthly, not seasonal.

If you want to use this letter to tell other dealers value of going "RCA all the way" you have my permission. I wish to help you because you have helped me.

Cordially yours,
 GODIN'S INC.
Milton Godin
 Milton Godin



← S. SIMON,
 RCA All the Way Dealer
 in New York City, says:
 "It took a lot of convincing to make me go RCA All The Way . . . but the steady sales I've had ever since make me regret I didn't do it sooner."

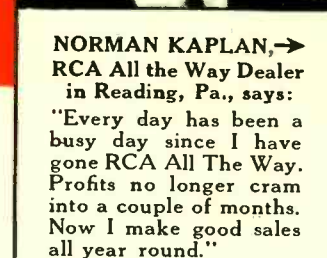

NORMAN KAPLAN, →
 RCA All the Way Dealer
 in Reading, Pa., says:
 "Every day has been a busy day since I have gone RCA All The Way. Profits no longer cram into a couple of months. Now I make good sales all year round."



← JOSEPH FEINBERG,
 RCA All the Way Dealer
 in Marshfield, Mass., says:
 "Going RCA All The Way has not only cut down my inventory, but has produced a variety of steady business that I missed for a good many years before I began stocking RCA's complete line."



CLASS OF
 This is a full-rate Telegram or Cablegram unless its deferred character is indicated by a suitable symbol above or preceding the address.

WESTERN UNION (04)

219 Market St. Camden, N.J. 08101
 PT98 48 4 EXTRA COLLECT=NEWARK NJ OCT 29 353P
 RCA MFG CO=CA=

HOW AM I DOING AS AN RCA ALL THE WAY DEALER? SWELL NO MORE HEADACHES ABOUT WHAT TO DO DURING DULL MONTHS BECAUSE THERE ARENT ANY. RADIO LINE SELLING LIKE WILD FIRE. GOING RCA ALL THE WAY WAS BEST THING I EVER DID= JACK SINGER SALES MANAGER LIGHTNING ELECTRIC SERVICE CO NEWARK NJ.

THE COMPANY WILL APPRECIATE SUGGESTIONS FROM ITS PATRONS CONCERNING ITS SERVICE

Proof THAT IT PAYS
 TO GO "RCA ALL THE WAY"

RCA Victor

RCA presents the "Magic Key" every Sunday, 2 to 3 P. M., E. S. T., on NBC Blue Network



RCA Manufacturing Company, Inc., Camden, N. J. • A Service of Radio Corporation of America

SETS + RECORD PLAYERS + TUBES + COMMERCIAL SOUND + PARTS = Dollars for You

PREVIEW OF NEW RADIO MERCHANDISE



COUCH

A Code Call System which instantly sends a coded signal to all parts of a building to locate executives has been marketed by S. H. Couch Co., Inc., North Quincy, Mass.; unit is usually placed near telephone operator as party wanted phones for message; 10 and 20 code call sizes; consists of 3 units—code call unit, power cabinet and series of audible and/or visible signals

A 12 volt vibrator power supply to be used on airplanes, buses and motor boats for powering radio transmitters, receivers and direction finding equipment can be obtained from P. R. Mallory & Co. Inc., Indianapolis, Ind.; normal maximum output, 300 volts at 100 ma.; shown installed on a Stancor portable transmitter

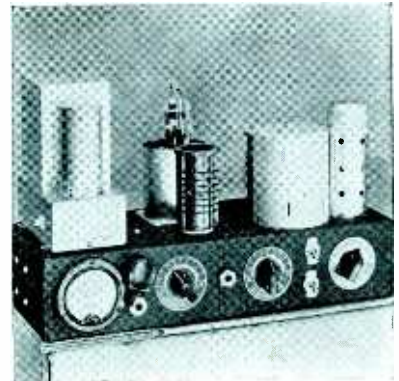

MALLORY

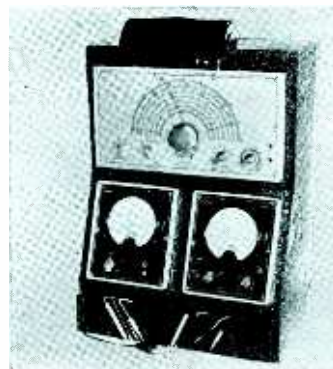

TRIPLETT

Laboratory Tests Bench Panels, in three cabinet styles may be obtained from Triplett Electrical Instrument Co., Bluffton, Ohio; offer facilities for a complete service laboratory; any Triplett master or deluxe tester may be installed; Model 1403, shown, accommodates one deluxe and two master testers; testers easily removed for field use

"Spot Light" tuning is employed in the Model 581 signal generator just brought out by Supreme Instruments Corp., Greenwood, Miss.; hairline indicating shadow-tuner "spotlights" the individual range and frequency desired eliminating parallel; 340° dial has an actual scale length of over 8 ft.

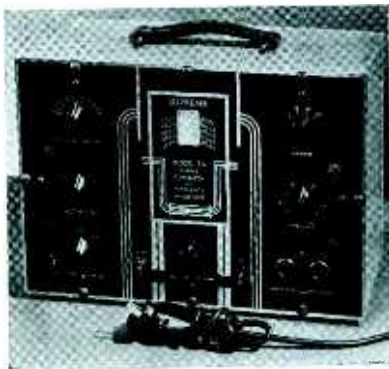

SUPREME

Through the addition of a self-contained Demodulator, Model RFO-4 oscillograph of the Hickok Electrical Instrument Co., Cleveland, Ohio, has more than twice the coverage; single or consecutive stage by stage trouble shooting from antenna post to speaker is possible; return trace eliminator; 11x13x15 in.

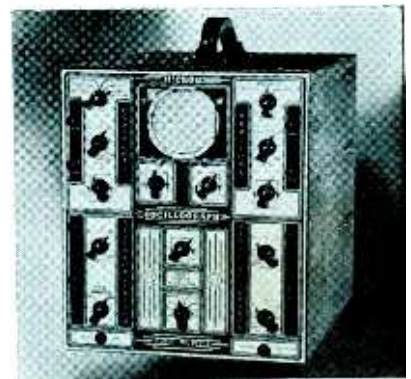

HICKOK

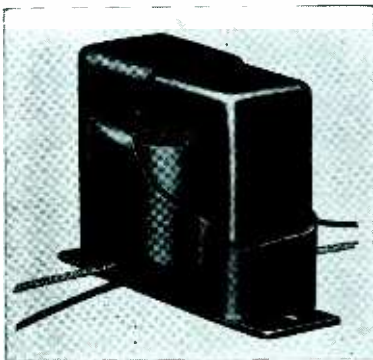

JEFFERSON

The line of "Plastic-Sealed" transformers recently introduced by the Jefferson Electric Co., Bellwood, Ill., has been augmented and now includes audio, input, output and inter-stage transformers and chokes; the delicate windings are completely protected at all times; the plastic jacket in non-brittle



BRUSH

A complete line of vibration pickups of typical piezo-electric Rochelle salt crystal design and applicable to the study of noises and vibration in various industrial applications is announced by Brush Development Co., 3311 Perkins Ave., Cleveland, Ohio; characteristics are such that they cover the complete frequency range

PREVIEW OF NEW RADIO MERCHANDISE

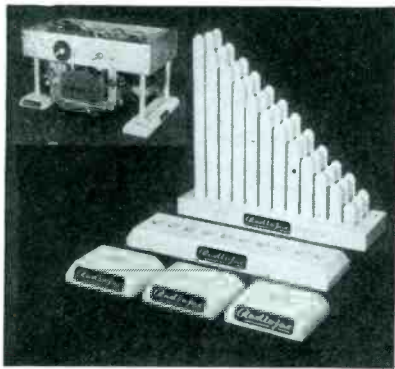

RADIOJAC

"Radiojacs" to support radiochassis for repair work may be obtained from Cooks Mfg. Co., 274 Mile Square Rd., Yonkers, N. Y.; will hold any size or shape chassis; chassis is free to be turned back and forth without interfering with leads; 36 hardwood rods varying in length from 1 1/2 to 8 in., benchstand and four bases are \$1.60 net.

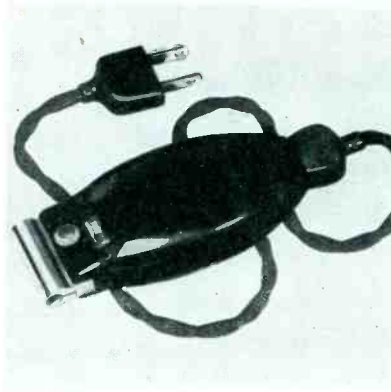

PACKARD

A smooth round cutting head, which has no edge or corners to nick or irritate, distinguishes the Packard Lektro-Shaver obtainable from the Progress Corp., 1 E. 43rd St., New York City; makes a splendid side line for the Xmas season; operates on 110 volt ac-dc; cleans and sharpens itself; \$15

A permanent magnet dynamic unit for use with any standard air column trumpets may be obtained from University Laboratories, 191 Canal St., New York City; will handle 25 watts continuously and up 50 watts peak; overall size 5 in. in diameter by 4 in. high; ruggedly constructed to withstand hard service



UNIVERSITY

A tamper-proof, factory sealed container with "Pillow Top" construction and a conspicuous date line showing time of manufacture are important merchandising features of the new line of A, B and C batteries offered by the Bond Electric Corp., New Haven, Conn.; plug-in connection is covered by a tamper-proof Safety-Seal



BOND

DISTRIBUTORS STOCK WINCHARGER
REG. U. S. PAT. OFF

New
GOVERNING PRINCIPLE PROVED "TOPS"

SURVIVES GRUELLING TESTS
In "wind tunnel" tests by a leading midwestern university, the new Model '38 6-volt Wincharger competed with other 6-volt radio chargers and came off with TOP HONORS. Wincharger developed more current at 8, 10, 15 miles wind velocity. At 45 miles Wincharger alone showed no vibration. Even at 70 miles, hurricane speed, Wincharger's new "pressure-control" operated perfectly. No other machine survived at this speed!

NEW MERCHANDISING PLAN ENABLES DISTRIBUTORS TO HANDLE WINCHARGERS Profitably FOR CONVENIENCE OF DEALERS

Now dealers will be able to get **QUICK DELIVERY** on Winchargers direct from their radio distributor. With a quick source of supply they can *more profitably* push the sale of Winchargers and battery radios, for they can pick-up Winchargers at the same time they get their battery radios... can often have a Wincharger shipped with a battery radio for no extra freight cost. With Winchargers readily available, dealers can deliver them to their customers at the same time they deliver their radio, thus avoiding the delay

of ordering a Wincharger from the factory and making a second trip to the country when it arrives. **DEALERS** are enthusiastic with this new plan which gives them quick delivery on Winchargers. **DISTRIBUTORS** are contacting their dealers **NOW** in order to anticipate their orders and have an adequate stock of Winchargers on hand. **DISTRIBUTORS** — If you are not familiar with Wincharger's new **PROFIT PLAN** for **DISTRIBUTORS** write or wire Dept. RR for complete details.

WINCHARGER CORPORATION, SIOUX CITY, IOWA
World's Largest Makers of Wind-Electric Equipment



**"Since installing Ken-Rad Tubes
reception is indeed clearer and better"**

**Mrs. Ruth M. Landollna,
621 Merton Ave., Memphis, Tenn.**

Satisfy customers and increase profits with Ken-Rad Tubes. The Ken-Rad name is well known and attracts new trade.

Ken-Rad Electric Light bulbs share the prestige of the Ken-Rad name. They give efficient lighting with real economy.

Ken-Rad

**KEN-RAD TUBE & LAMP CORPORATION, INC.
OWENSBORO, KY.**

Now electrical manufacturers
can meet 1938's sales problem

-and increase sales and profits

In 1938, radio and accessories manufacturers will face an increasingly difficult sales problem—that of winning the support of electrical wholesalers' salesmen.

Though indications point to another marked increase in radio and accessories sales, the individual manufacturer will encounter increasingly intense competition. For other manufacturers will more strenuously seek the support of electrical wholesalers' salesmen to get their proportional share of these salesmen's estimated \$60,000,000 sales of radio and accessories for 1938.

This means that the individual manufacturer *must* redouble his efforts to sell these salesmen—

on CONTINUING their present support for his line

on INCREASING their sales efforts on his line

He must use the most forceful, direct and effective route if he successfully meets next year's sales problem.

And in 1938, that route is

THE WHOLESALER'S SALESMAN

a publication promoting greater sales and profits
for the manufacturer and his wholesalers' salesmen



A MCGRAW-HILL PUBLICATION



THE WHOLESALER'S SALESMAN

Formerly ELECTRICAL WHOLESALING

330 West 42nd St.

New York, N. Y.

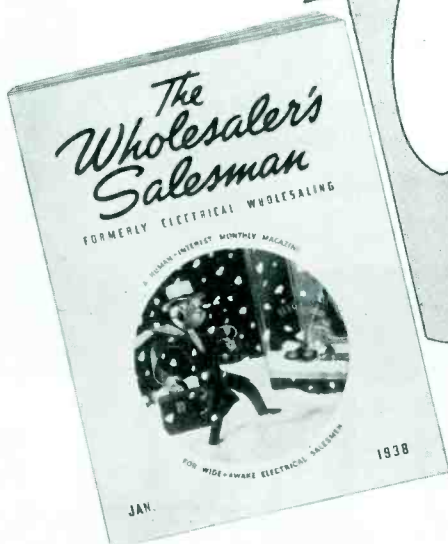

FIGURES

UTILITIES' STAKE IN RADIO

An important radio manufacturer, urging public utilities to take advantage of the opportunities in radio, points out that the number of sets installed in the home outnumber any other electrical appliance with the exception of flat irons. Second, radio brings more revenue to the power companies than any other appliance with the exception of refrigerators. It is estimated that radio offers the power companies a potential annual revenue in excess of \$85,000,000.

Further opinion is that 15 per cent of all radios less than five years old are inoperative, and 30 per cent are in only fair or poor operating condition, which of course results in less use. Calculations of losses in listening time due to conditions that may be remedied point to an annual revenue loss to utilities of approximately \$15,000,000.

3 CITIES—50% OF SETS

Chicago, Philadelphia and Camden produced more than half of all the radio sets manufactured in the United States during the last fiscal year.

The detailed report on radio excise tax collections which brings this concentration to light places total collections in the first Illinois tax collection district, comprising Chicago, at \$1,726,133.46. The first New Jersey district,

including Camden, was second with \$1,177,898.22 and the 1st Pennsylvania district, including Philadelphia, was third with \$906,552.22.

\$49,000,000 FOR RADIO TIME

During the first 9 months of 1937, advertisers spent \$49,072,837 for the use of the air waves. Figure is 25 per cent higher than revenue for the same period last year.

September volume, \$3,879,166 was 3.25 per cent over income for the corresponding month in 1936.

RETAIL CREDIT GAINS

12,004 retail stores in 40 cities averaged September increases of 1.4 per cent in collections, 5.9 per cent in credit sales, and 5.8 per cent in total sales as compared with the same month a year ago, reports the Research Division of the National Retail Credit Association.

SET A SECOND

H. C. Bonfig, sales manager of RCA Mfg. Company, has estimated that 54 radio sets were purchased every working minute of every working day during

HOW SIZE OF INCOME AFFECTS REFRIGERATOR PURCHASES			
PER CENT OF ALL FAMILIES	FAMILIES BY INCOME CLASSES	PERCENT OWNING MECHANICAL REFRIGERATION	PERCENT OWNING AUTOMOBILES
4.8	No Income	8.4	34.2
21.7	\$1 — 499	3.8	29.7
23.3	\$500 — 999	8.4	44.4
19.2	\$1000 — 1499	17.4	60.9
13.4	\$1500 — 1999	28.7	71.3
10.8	\$2000 — 2999	42.9	79.6
4.9	\$3000 — 4999	60.6	86.9
1.1	\$5000 — 6999	73.8	91.7
0.8	\$7000 & Over	81.4	94.6
100.0	All Classes	19.4	54.3

Based on a Dept. of Commerce Survey of 250,000 families in fifty cities.

the past year. The chances are bright that this year it will be 66 sets a minute, a nice little gain.

Come to think of it, though, in a little over 15 years the annual volume of radio business has increased over 900,000 times!

STUDY RADIO'S INFLUENCE

On the strength of Rockefeller Foundation's gift of \$67,000, Princeton University, among most famous of the ivy colleges, is preparing to make a searching analysis of the effect of radio on everyday life.

Actively participating in direction of research work will be Frank Staunton, Columbia Broadcasting System executive.

SALES OF PRIMARY RADIO DEALERS

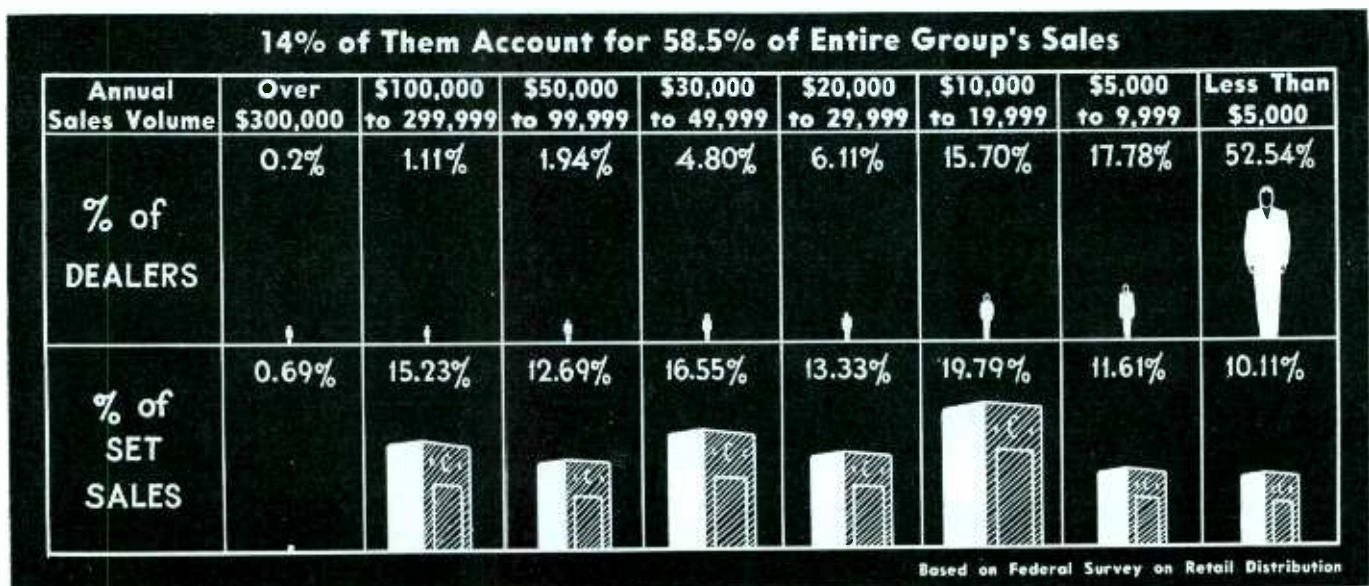

all wires busy

NOT in years has there been such a heavy demand for wire in connection with the Serviceman's business. You have noticed it—we have noticed it.

With Public Address going like a prairie blaze and Radio a seething hotbed of activity which promises to be sustained, you will be needing GOOD WIRE.

CORWICO Wires are scientifically produced to do their job 100%. Antenna Systems, P-A Cables, Hook-up Wires—"made by engineers for engineers." Use CORWICO on your next contract.



NOISE-MASTER
ALL-WAVE ANTENNA

Eliminates "Man-Made" Static on Broadcast as well as Short Waves

LICENSED by Amy, Aceves & King, engineered with traditional CORWICO care, this masterly aerial system fits every set and every location. Filters out nuisance noises caused by electrical devices. Improves reception generally—widely endorsed by Service men.

No. 14 (illustrated above) **\$6.75 list**

FOR broadcast and shortwave frequencies; designed to eliminate "man-made" static and afford better reception. Two to 6 sets can be operated at the same time with an additional lower transformer for each added unit. Other "Noise-Master" units available.

WRITE FOR INFORMATION.

CORWICO Wire Catalog available to Service men.
Distribution is exclusively through Jobbers.

CORNISH WIRE CO., Inc.
30 Church Street  New York, N. Y.

HERE'S DEWALD -
first with instantaneous automatic



TOUCH TUNING

at a popular price!

7 TUBE MODEL

\$34.95

NEW easy-vision "tilt-front" CABINET

Real honest-to-goodness instantaneous automatic touch tuning at a sensational price. It's noiseless, foolproof, accurate, instantaneous! DeWald Model 701 has a dozen other features that make it a "natural." Get in on the ground floor, increase your sales volume with this profit-maker—choice territories available to distributors, jobbers, dealers. **WRITE TODAY!**

LOOK AT THESE FEATURES: 7 tubes with 12 tube performance. AC-DC super het, tunes standard broadcast, police, state. Stations maintain stability, full a.v.c., dynamic speaker, beam power amplification over 2 watts, fidelity modulation adjustor on tone control. Large instrument flood lit dial, full-size chassis, noiseless antenna system. Cabinet: 16"x10½"x7".

A COMPLETE LINE OF 21 OTHER HOME AND AUTO RADIOS FROM \$16.75 TO \$99.50

Tops since 1921

DEWALD

Tops in 1938

PIERCE-AIRO, INC., 512 SIXTH AVE., N. Y. C.

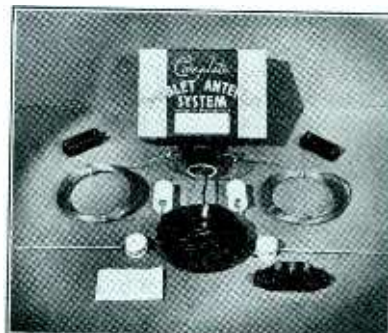

NEW ANTENNA
BATting 1000%
No Slump

This Season!

Completely assembled ready to install. New type top coupler housing. No. 6066. List Price \$3.25.

Sold Through Distributors Only. Send for complete information.

RIVARD WIRE AND CABLE CORP.
1014 Madison Avenue
Toledo, Ohio

We Take Pleasure in Announcing That
McMURDO SILVER CORP.

is now merchandising its custom-built radios and radio phonographs through strictly and rigorously exclusive

MUSIC MERCHANTS AND THE FINER RADIO DEALERS

To those qualified for, and seriously desiring appointment as exclusive McMurdo Silver dealers for their cities or territories, full details will gladly be forwarded.

McMURDO SILVER CORP., 2900 S. Michigan Ave. Chicago, U.S.A.

NEWS

New "No Discount" Drive

WRRAA again asks Milwaukee industrialists to help stop evil trade practice

MILWAUKEE—Signed by president Frank W. Greusel and executive secretary H. L. Ashworth of the Wisconsin Radio, Refrigeration & Appliance Association, a new series of six letters designed to discourage purchase of household items at discounts goes into the mails to industrialists here as we go to press.

Similar in approach and tone to those used so successfully last season (RR Nov. 36), the letters point out the danger to local merchants when big factories and manufacturing plants encourage or make it easy for their employees to by-pass normal trade setups.

Response so far, according to the Association, has been extremely favorable.

Big Radio Drive On Coast

Utility, appliance league, distributors, dealers cooperate

SAN FRANCISCO—Concluding just as *Radio Retailing* goes to press is a fall radio sales campaign staged jointly by radio distributors and dealers, the Pacific Radio Institute, Electric Appliance Society and the Pacific Gas and Electric Company.

In the campaign period between October 11 and 30 it is estimated that the group secured virtually blanket coverage of the market with promotional expenditures exceeding \$100,000. Free broadcast time was obtained over several chain stations. Bill-stickers were sent to 200,000 domestic customers of the Utility. Cooperative displays were installed in 73 power company offices. The Utility advertised the advantages of radio in 285 daily and weekly papers. Dealers used special window displays. And slides promoting the campaign slogan: "You're There in Person With 1938 High-Fidelity Radio" were shown in 72 small town movie theatres.

Arthur Rowe, managing director of the Pacific Radio Institute arranged an initial meeting at which representatives of cooperating groups voiced their enthusiasm for the joint effort. Frank Runyan, managing director of the Western Furniture Mart, where the meeting was held, pointed

out the interrelation between the sale of good furniture and of high-class radio models. V. Ford Graves, chief inspector of the FCC for the district, submitted an idea on the psychological approach to selling better receivers. William B. Ryan, sales manager for the NBC in San Francisco lauded the movement, said broadcasters as well as the trade wanted better sets in homes. E. M. Frelson, district appliance sales manager of the G. E. Supply Corp., spoke about distributor-dealer rela-

tions. Hugh M. Crawford, general sales manager of Pacific Gas and Electric, outlined in detail, the plan under which the cooperative drive was to go forward.

Clark Upped

NEW YORK—Bonnell W. Clark has been elected president of the Westinghouse Electric Supply Co., stepping up from the position of vice-president and general manager.



DISCUSS BRIGHT IDEA—In the offices of the Electrical Association of Philadelphia radio, utility and electrical league men debate possibility of interesting all three groups in joint radio checkup plan. Left to right: Harry Boyd Brown of Philco, G. Bertram Regar of Phila. Electric, Vance Woodcox and Eugene Deacon of RCA, Ernest Vogel of GE, C. E. Greenwood of the Edison Electric Institute and J. S. Bartlett of the Electric Institute of Washington, D. C. Present but not pictured: Ralph Neumuller of the Electrical Association of N. Y., George Whitwell of Phila. Electric, Robert Herr of Philco and W. MacDonald of "Radio Retailing"



STARTED IT ALL—Harry Boyd Brown, who suggested League cooperation in radio promotion during an October speech in New York



SUGGESTED CHAT—George Conover, president, International Ass'n. of Electrical Leagues and manager, Elect. League of Phila.

RSA Snowball Rolling

New service group interests IRSM, NRSA and RTG, elects temporary officers

CHICAGO—From Jerome J. Kahn, trustee of the Radio Servicemen's Association formed last month with the support of the Sales Managers Club and a group of manufacturers for the purpose of amalgamating radio service organizations into one cooperative group, comes word that following a meeting October 1, 2 and 3 in New York and another October 10 and 11 in Chicago temporary officers have been elected. T. P. Robinson of Dallas is president; Albert C. W. Saunders of Boston, vice-president; Ingvar Paulsen of Boston, secretary and Lee Taylor of Chicago, treasurer.

Aiding in the formulation of a new RSA charter were representatives of various affiliating IRSM chapters, the NRSA and the RTG of the New England states. Planned is refusal of membership in the RSA to applicants who are not approved by affiliated local groups, issuance of a monthly house organ, advance equipment circuit diagrams, instruction material, membership decalcomanias and certificates, nominal annual dues.

This material is to emanate from offices at 304 South Dearborn Street.

Ladies And Gentlemen, The Winnahs!

Philco distributors step up and collect Double-X merchandising contest honors

PHILADELPHIA — Winners in the nationwide contest for merchandising honors in the Double-X Philco line stepped up October 16 to receive awards. They included: Group 1: First, Philco Radio and Television Corp. of New York; Second, Roskin Bros., Inc., Boston, and Third, Listenwalter & Gough, Los Angeles. Group 2: First, Beaucaire, Inc., Rochester; Second, Appliance Wholesalers of Oregon, Portland, and Third, Tri-State Distributing Co. of Cincinnati. Group 3: First, The Mathes Co., Fort Worth; Second, San Diego Standard Electric Co., San Diego; and Third, Biehls, Inc., Pottsville, Pa. Group 4: Schmiers Radio Shop, Rock Island, Ill.; Second, Pioneer Hardware & Music Co., Burlington, Kansas, and Third, C. S. Blodget Co., Inc., Burlington, Vt.

Numerous honorable mentions were awarded.

Southern Kadette Splash

NEW ORLEANS — James Woods, southern division sales manager for the International Radio Corporation, has just opened an elaborate suite of offices in the Perdido Building at 822 Perdido St., invites distributors and dealers to see the entire Kadette line there.



HEADS NRPDA—Leslie Rucker, Rucker Radio of Washington, who heads up National Radio Parts Distributors Association as president

NRPDA Officers Re-elected

Distributor group further develops organization plans

NEW YORK—From the executive secretary of the National Radio Parts Distributors Association at Room 1701, 1270 Sixth Ave., comes the following news relative to the activities of this group:

Membership is now 150. Sixteen regions have been designated, each to have its own regional organization, elect its own regional director to serve on the Board of Directors. National headquarters will coordinate the activities of regional bodies, contacting manufacturers where necessary. Officers elected last June were recently re-elected to serve until next June. They include Leslie Rucker of Washington, D. C., president; Joseph Demambro of Boston, secretary-treasurer, and Blakely Gross of Gloversville, N. Y.

At the last meeting dues were set at \$12 per year and an attorney was retained to insure strict legality of all procedure.

Frigidaire Ranges, Washers

DAYTON—New lines of electric ranges and electric washers to be manufactured by the Frigidaire Division, General Motors Corp., will be marketed under the trade-name "Frigidaire", says Frank R. Pierce, manager of this firm's household division, after consultation with dealers, salesmen and distributing organizations.

Promotion For Powel III

CINCINNATI—Powel Crosley III, for some time a vice-president of the Crosley Radio Corporation, has now been put in complete charge of the radio set manufacturing division of the company. J. P. Rogers, also a vice-president, has been placed in charge of the private brand division which covers the sale of automobile radio sets to car manufacturers and special brand radios and refrigerators to large users.

High-Line Propaganda Hurts Sales

Agricultural publications urged to tell farmers how long it will be coming

CHICAGO—At a meeting held here late last month representatives of leading agricultural publications were told by Walter F. Dunlap, adman for Briggs & Stratton, that rural electrification propaganda widely circulated far in advance of actual accomplishment gave many farmers the impression that high-lines in their area were "just around the corner," slowing down normal and desirable distribution of appliance purchases.

Said Mr. Dunlap: "Because of the propaganda that has been disseminated by farm papers and newspapers throughout the United States all over this country we have found families thinking that high-lines would be installed in a mere matter of months. This has resulted in a slowing up of normal purchases. Farmers put off buying battery sets because they think they will soon be able to plug in on high-lines. They deny themselves the advantages of gasoline-powered washers, milking machines, separators, feeling the blight of this propaganda. But what are the facts . . . Out of 6,422,000 farms there will be more than 4 million without high-line service in the year 1945! Farm electrification is going ahead at only 3 per cent a year."

Continuing, Mr. Dunlap pointed out that: "REA is following the private utilities in skimming off the cream, offering highlines



SAYS "TELL ALL"—Walter F. Dunlap (handkerchief in pocket) talks with Lee Archer, Charley Bronson and Kurt Toel of "Country Gentleman"



INTERESTED LISTENERS—Ray Randall and Ed Oehler of Briggs & Stratton

where there is the greatest concentration of farmers. There must be at least 3 farms per mile, which leaves a lot of States like Nebraska where there is an average of 1.6 farms per mile. Such places are long likely to be without electrification."

"Masterpiece" Line Back To Trade

Old-line music stores to get
McMurdo Silver merchandise on
distributor basis as firm drops
direct-to-consumer policy

NEW YORK—Interviewed at the Hotel St. Regis upon his return with Mrs. Silver from a 6-weeks trip to England, where the British McMurdo Silver Co., Ltd., was formed, McMurdo Silver, Chicago set maker for some time engaged exclusively in the sale of equipment direct to the consumer, announced a new company policy.

Effective immediately, the McMurdo Silver Corp. will discontinue the sale of "Masterpiece" receivers direct to consumer, employing old-time music stores with exclusive territories as dealer-distributors, permitting them to sell over the counter themselves, re-sell to other retailers in their territory where clientele does not conflict, or both. Already interested in the line which includes models from \$197.50 to \$580 (phono-combination), according to Mr. Silver, are Lyon & Healy of Chicago; Jenkins Music, covering Kansas City to Texas; Aeolian of St. Louis; Sherman-Clay on the West Coast and Davega-City Radio of New York. Negotiations calculated to insure absorption of a 10,000 to 20,000-set annual production are still in progress between the manufacturer, these and similar key music accounts.

Promised are discounts sufficiently broad to permit a distributor's profit, flexibility of resale price to permit reasonable adjustment to suit local conditions at the discretion of individual dealer-distributors, completely protected territories, continuance of direct-to-consumer advertising and relaying of leads resulting to the trade.

N.U. Condenser Line

Tube maker to offer complete list
of electrolytics, papers, oils

NEW YORK—The National Union Radio Corp., prominent tube manufacturer, is to have a complete line electrolytic, oil-filled and paper condensers. Boxed in gold, black and green containers, these will be available for use in the radio service field, according to H. R. Peters, president.

Triumph Testers In Tube Deal

CAMDEN—Five "Triumph" instruments, including three tube-testers, a signal-generator and a multi-range meter, are being used in a current RCA tube promotion.

RADIO RETAILING, NOVEMBER, 1937



STROMBERG'S NEW G.M. — *Lloyd Spencer*, for the past nine years sales manager for New York's Gross Sales and New England rep for S-C. Started his business career with Columbia Phonograph in K.C., joined J. W. Jenkins Music and did a record job for 11 years, was sales manager for American Amplion, then went with the old Gross-Brennan. Plays golf in the 80's

Gross Advances Wolfe

NEW YORK—John G. Wolfe, with Ben Gross of Gross Sales since 1922, has been made office manager and New England representative for New England. In addition, he will continue in charge of the service and parts supply department.

Credit Committeeman

BROOKLYN, N. Y.—Victor Mucher of the Clarostat Mfg. Co., Inc., has been elected vice-chairman of the Eastern Credit Committee of the RMA, succeeding Ed Metzger.

Three To Majestic

CHICAGO—Three new salesmen have been appointed by the Majestic Radio & Television Company to cover Missouri and lower Illinois, with headquarters in St. Louis. They are Loren M. Wood, Moncrieff H. Smith and E. W. McGrade.

Dayton Radio Formed

D. E. Johnson heads new
test instrument firm

DAYTON, OHIO—Formed here October 22 by D. E. Johnson, at one time president of the Day-Rad Company and for the past two years sales manager for the Bendix-Dayrad Division of the Bendix Products Corp. of South Bend, Ind., the Dayton Radio Corporation will shortly begin production of a new line of test equipment for the radio and allied fields.

By arrangement with Bendix the new firm will henceforward also provide renewal parts and authorized service on Dayrad and Bendix-Dayrad equipment now in use.

New Inter-Communicator Maker

Radiofone Corp. demonstrates
wireless model to trade and press

NEW YORK—At a meeting held October 27 in the offices of the Radiofone Corporation, 136 W. 22nd St., sales manager Joseph S. Klein demonstrated to the trade and to representatives of the press a new "wireless" type inter-communicator incorporating a new idea in power line connection designed to eliminate the necessity for bridging individual lines with condensers to provide a radio-frequency path when units are widely separated.

Equipped with a five-point selector switch, one unit was used to communicate with an employee 9 floors below. Another instrument was demonstrated from a restaurant several buildings away.

Kierulff Expands

LOS ANGELES — Kierulff & Co., southern California distributor of the "Admiral" set line, has just doubled its floor space by taking over the building next to its 1839 S. Flower St. address, installing a double-width window. In training all summer for an active merchandising season has been Charley Kierulff, genial manager of the outfit, who traces his ancestry back to the hardy Norsemen, is a sailor who scorns engines.



SEE NEW GE's IN NEW ORLEANS—Two hundred dealers saw G. E. Supply unveil new General Electric radios last month at the Monteleone Hotel

A BEST SELLER AMONG RADIO DEALERS!

The new—pocket size

“RADIO TRADE-IN ALLOWANCE BLUE BOOK”

to

—end the bickering and trouble over a fair trade-in price and to —help radio dealers make a decent net profit on set sales!

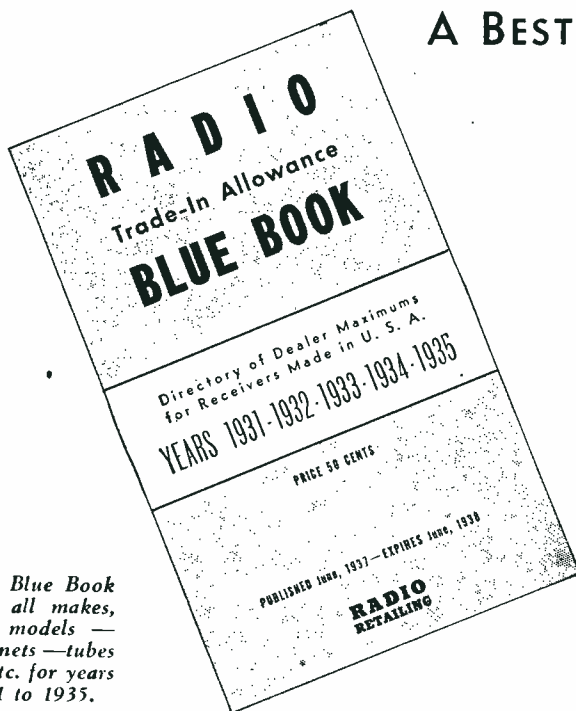

The Blue Book lists all makes, and models — cabinets — tubes — etc. for years 1931 to 1935.

Radio Dealers can use this handy "Trade-In Blue Book" to

- end the wrangling over the proper "trade-in" allowance on an old radio set.
- establish a basis for appraising old receivers so that a legitimate net profit is obtained on the new set sale.
- give official appearance to the "trade-in" allowance quoted the customer.
- to offset competitive allowances which are out of line with a just valuation.
- refer to in front of customer and show that the figure the dealer quotes is in excess of the suggested allowance for any set.

ORDER YOUR COPIES TODAY

Do "trade-ins" make your store a battle-ground? Every radio dealer has to face the problem of appraising "trade-in" sets on which too generous an allowance wipes out the net profit from the sale of a new receiver and too small an allowance drives the customer to a competitor's store.

To help dealer's arrive at a just "trade-in" allowance figure, Radio Retailing has published the first authentic, comprehensive directory of "trade-in" maximum allowances ever compiled for radio receivers made in this country from 1931 to 1935. This un-paralleled data appeared in Radio Retailing's June issue but the immediate demand for it was so wide spread that the entire directory was reprinted in a handy, pocket-size book and is now offered to the trade at a nominal price.

Every radio dealer should have this book on his counter and in the hands of his salesmen. It can be used to drive home to the customer a semi-official "trade-in" figure which is fair to the dealer and will insure a legitimate profit on the sale of any receiver. An investment of 50c in the TRADE-IN ALLOWANCE BLUE BOOK may save you hundreds of dollars in the course of the year and eliminate most of the headaches arising from lengthy arguments with your customers.

Order a copy of the "Radio Trade-in Allowance Blue Book" for your store today and you'll be surprised at its value as a year around selling aid. Simply attach the coupon to your letterhead and mail it with the fee.

**SINGLE COPIES
50c Each**

Quantity Rates as Follows:

- 25-99 Copies—40c each
- 100-499 Copies—35c each
- More than 500 Copies—25c each

All Orders for Less than 10 Copies Must Be Accompanied by Full Remittance in Currency, Check or Money Order

USE THIS HANDY COUPON TO ORDER YOUR COPIES TODAY

RADIO RETAILING
330 W. 42nd St., New York, N. Y.

Gentlemen:

Attached is \$.....for which you are to send mecopies of the handy, pocket-size "RADIO TRADE-IN ALLOWANCE BLUE BOOK" by return mail, postage pre-paid.

Remittance Must Accompany This Order

Name

Firm

Street

City State.....

RR10-37

TUBE and

TESTER Men



at the New York Show



... time out for a hot-dog. WENGER of Triplet



... has important assignment. WILDER of National Union



... nothing but work. KOCH of Simpson



... talk's radio amateur's language. PURINTON of Raytheon



... asked embarrassing question. STEINLE of Triad



... discussing new flood of orders. KLEIN and MACK of Precision



... says it with lights. MANLEY of Radiotechnic

... debonair and decorous. GEARTNER of Arcturus



Dry-Shaver Statistics

Over 3,000,000 sold in U. S. to date, many by radio trade as sideline

NEW YORK—There are over 3,000,000 electric dry-shavers in use in the United States today, according to figures just compiled by *Radio Retailing* after checkup among leading manufacturers. Units in use retailed from \$7.50 to \$17.50, with the average at \$15.

Operating on 110 volts a.c. or d.c., with



NAME EVERYBODY KNOWS—John F. Rider picks up dope in person at the New York Parts Show



MISSES NO BET—Ben Abrams of Emerson looked over new stuff at the Port Authority Building Parts exhibit



ANSLEY OF ANSLEY—Another set maker who showed up to look over the Radio Parts Manufacturers Show Corp. exhibit, Arthur C. Ansley

models also available for 6 and 32 volt d.c. systems, the dry-shaver has attracted the attention of the radio trade, is considered by many to be an attractive sideline, particularly as the Christmas holiday approaches. Realized by dealers who have already merchandised the item is the fact that it is most readily sold by men who use it themselves, are sold on its convenience, efficiency. Also known is the fact that despite the dry-shaver's obvious advantages to both men and women effective promotion is essential if the consumer is to change shaving habits of long standing.

Partial list of manufacturers (more producers are entering the field every day) follows:

Company	Trade Name
Clipshave, Inc., Port Chester, N. Y.....	Hanley-Clipshave
Jay Meyers Corp., 36 So. State St., Chicago	Greyhound
Electric Razor Corp., Merchandise Mart, Chicago	Majestic
Motoshaver, Inc., Van Nuys Bldg., Los Angeles, Calif.....	Motoshaver
Nicholl, Inc., 766 East 12th St., Los Angeles, Calif.	Nicholl Velvet
Progress Corp., 1 East 43rd St., New York.	Packard Lektro-Shaver
General Shaver Corp., Bridgeport, Conn.....	Remington-Rand
Schick Dry Shaver, Inc. Stamford, Conn.....	Schick
Chicago Flexible Shaft Co., 5600 Roosevelt Rd., Chicago.....	Shavemaster
Miracle Dry Shaver Corp., 36 So. State St., Chicago.....	Miracle

Literature describing dry-shavers in detail may be obtained by writing these companies direct, or by request through *Radio Retailing*.

F,M Convention Dates Set

Will show new refrigerators
Nov. 15-16

INDIANAPOLIS—From W. Paul Jones, general manager of the Fairbanks, Morse & Co. home appliance division, comes word that inasmuch as most refrigerator manufacturers are introducing new lines considerably earlier this year, to obtain Christmas business and other advantages, Fairbanks, Morse will stage its national distributor's convention November 15 and 16 at the Columbia Club of this city.

Distributors attending at this early date, according to Mr. Jones, should be in shape to hold dealer meetings before December 4.

New Howard Exec

CHICAGO—George H. Mitchell has been made assistant sales manager of the Howard Radio Co., replacing Earl Losier, who now covers Michigan, Wisconsin and Minnesota.



PROMOTION PLANS READY—J. F. Ditzell and C. C. DeWees look over a typical folder

Stewart-Warner To Convene

Shows new "winking light" refrigerators November 11 and 12

CHICAGO—A bright-eyed little light that winks on when the motor is running and off when the motor stops will demonstrate to 1938 housewives the economical electricity consumption of next year's Stewart-Warner refrigerators. First to see the "Econ-o-lite" will be company distributors attending a convention planned here November 11 and 12.

Glass wool as insulation is used in new models shown *Radio Retailing*, will give Cliff DeWees, radio and refrigeration ad manager for the company, a chance to festoon it around in new displays.

John F. Ditzell, radio and refrigeration sales manager, promises to demonstrate 30 new refrigerator models to the crowd. Nine will be used in a platform display, six of them deluxe, running from 7.5 cu-ft. to 4.5.

Present to shake hands with distributors will be President J. E. Otis, Chairman of the Board J. S. Knowlson, and vice-president Frank A. Hiter.

Key Radio Boosters

West Coast association branch elects new officers

LOS ANGELES—At a regular meeting of the Radio Booster Club, Southern California, branch No. 1, the following officers were elected: president, H. W. Dunham; vice-president, N. B. Neely; secretary-treasurer, Gerald B. Miller.

The group is composed of radio manufacturers' agents and other executives engaged in the distribution of parts, sets and accessories, may be reached at 8208 Santa Monica Blvd.

Comun-A-Phone Shift

NEWARK—Comun-A-Phone Systems, Inc., is now located at 1175 Broad Street.

TRIAD

BALLAST TUBES
(Resistor Units)

**NOW AVAILABLE FOR
REPLACEMENT**

Assortment No. 1 Consists of 50 Units
(Assorted Types) Glass and Metal of
Fast-Selling Numbers

Assortment No. 2 Consists of 100 Units
(Assorted Types) Glass and Metal

Other Types Supplied on Request

Also a Complete Line of
Radio Receiving Tubes

A Profitable Line to Handle

TRIAD
MANUFACTURING COMPANY
INCORPORATED
PAWTUCKET RHODE ISLAND

The Quality Name in Radio

AMERICAN CODE READER



**A SMASH HIT FOR
DEALERS AND JOBBERS**

You have many customers who are "dyed in the wool" radio fans. They are "hounds for DX." They are constantly looking for a new thrill in radio! The American Code Reader brings it to them. Now a whole new field of exploration is opened up to these fans. They can catch code on tape and easily and quickly decode it. Our proven sales plan stimulates the sale of NEW receivers too! Get all the facts concerning the sensational American Code Reader as well as this new sales stimulating plan.

List Price, less tube (1-76) . \$20
Americode Tape, 250-ft. roll, 25¢

**AMERICAN
COMMUNICATIONS CORP.**
1650 Broadway New York, N. Y.
Dept. RR-11

EXIDE RADIO BATTERIES

CAPACITIES

Type	R.M.A. 100-hr. Rate Amp. Hrs.	Approximate OPERATING HOURS	Price, Each Consumer
2R-105	105	210 at .5 Amp. Drain	\$4.95
2R-160	160	320 at .5 Amp. Drain	6.95
2R-230	230	460 at .5 Amp. Drain	8.95
6R-100	100	50 at 2 Amp. Drain	11.10
6R-150	150	75 at 2 Amp. Drain	19.95

Other types and sizes described in folder.



PLAY FAIR with yourself when you sell a battery radio

When you sell a battery set, if you don't sell an Exide storage battery with it you are missing a bet.

Missing a bet because first there's substantial profit in selling the Exide line. And second, if your customer gets an inferior storage battery or a substitute, his satisfaction with his new radio will not be long lasting.

That's why it's wise and pays to

sell an Exide. They are especially designed radio storage batteries, built for long life and full power. Priced competitively to the set buyer, and sold to you at the regular radio trade discounts.

There are 2-volt and 6-volt Exides in various capacities, as well as 6-volt batteries for wind-driven chargers and gas-engine generator systems. Why not mail the coupon for full details?

THE ELECTRIC STORAGE BATTERY CO., Philadelphia
The World's Largest Manufacturers of Storage Batteries for Every Purpose
Exide Batteries of Canada, Limited, Toronto

Exide RADIO BATTERIES

THE ELECTRIC STORAGE BATTERY CO.
1900 W. Allegheny Ave., Philadelphia

Please see that I get complete details on your proposition.
My business is % retail % wholesale.

NAME _____
NAME OF FIRM _____
ADDRESS _____

The
ELECTRIC AUTOMATIC
LINE FOR 1938!

COMPLETE! OUTSTANDING!

Majestic

MIGHTY MONARCH
OF THE AIR!

Only Majestic, the complete Electric Automatic line of radios for 1938, offers you these profit-making features.

- Foremost developments in ELECTRIC AUTOMATIC TUNING.
- Lower costs and higher mark-ups.
- Merchandising sales helps.
- Complete range of models in every price class.

WRITE TODAY FOR DETAILS ABOUT
THE MAJESTIC FRANCHISE—THE
MOST VALUABLE IN RADIO!

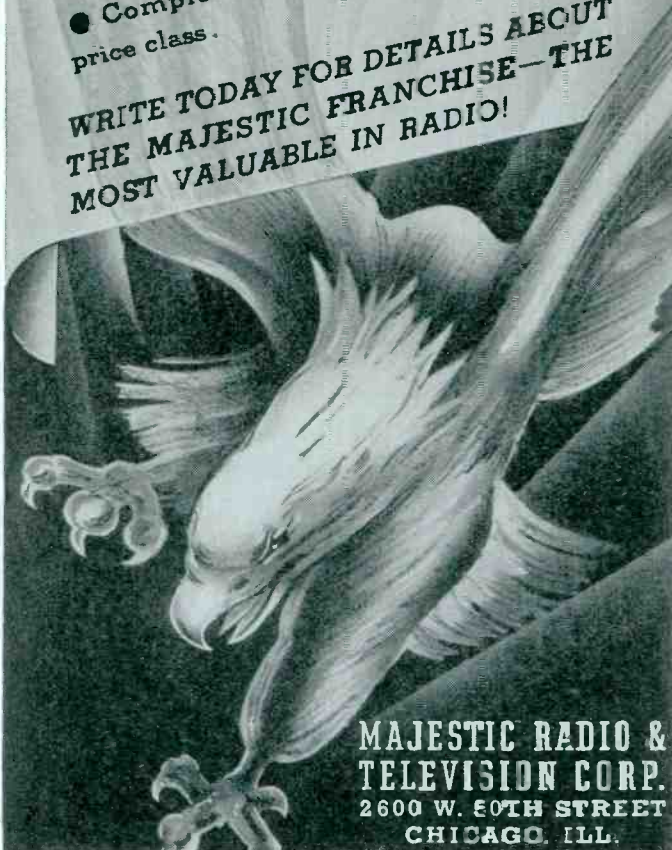

MAJESTIC RADIO &
TELEVISION CORP.
2600 W. 80TH STREET
CHICAGO, ILL.



THE NEW PERSONAL WASHER
by HORTON

DAINTIEST garments, finest fabrics, most prized possessions are easily, quickly, *safely* swished clean. No more bathroom "dunking"—no more "wash-bowl hands." Kleenette is for the daily washing of lingerie and stockings—for boiling and sterilizing—for tinting and dyeing—for dry cleaning (in non-inflammable fluid)—for the many between-wash cleansing jobs.

Get all the facts now about this sensational new development in home laundering help.

HORTON MANUFACTURING COMPANY, 1106 Osage St., Fort Wayne, Ind.

HORTON WASHERS - IRONERS SINCE 1871

Janette Rotary Converters

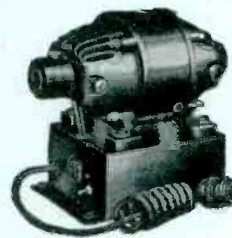

The original D.C. to A.C. converters with all wave filters developed exclusively for radio and sound apparatus.

CAPACITIES: 35 to 3250 watts.
6, 12, 32, 115 and 230 volts
D.C. to 110 or 220 volts, 1 phase,
60 cycle A.C.

Insist on a Janette
Ask For Bulletin No. 13-25

Janette Manufacturing Company

556-558 West Monroe Street Chicago, Ill. U. S. A.
BOSTON - NEW YORK - PHILADELPHIA - CLEVELAND - MILWAUKEE - LOS ANGELES
DETROIT - SEATTLE

Noise-Free Store Demonstrations Make Sales Easier

PUR-A-TONE MULTIPLE ANTENNA

(Includes Low-Loss GIANT KILLER CABLE)

Insures Perfect Radio Performance

LICENSED UNDER PATENTS OF AMY, ACEVES & KING

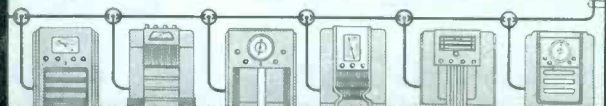

L. S. BRACH Mfg. Corp.

Newark, N. J.



Est. 1906

PARTS MEN

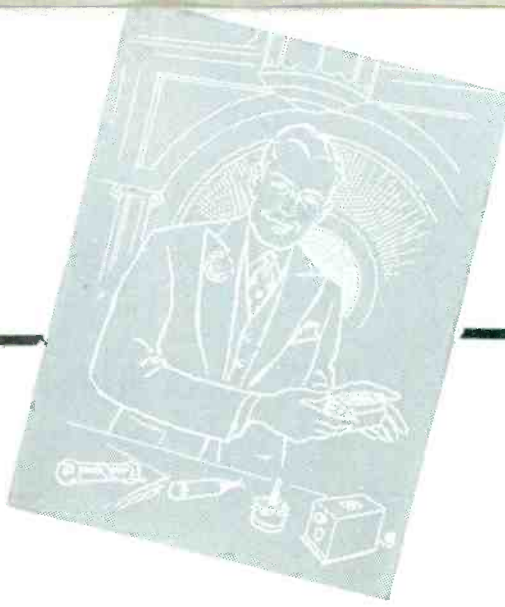

... black hat matches little black book. **GOLEPAUL** of Aerovox and **SEIGEL** of Ohmite



... effective new team. **MOSS** (at the left) and **HARTER** of Solar



... man in the middle. **WILLIAMS** of International Resistance, **SAFTLER** (making notes) of "the Representatives" and **HATHAWAY** of the Show Corporation



... never caught napping. **KAHN** of Standard Transformer (smiling, as usual) and **Bill Schuler** of New Orleans



... a sale, in all seriousness. **VIC MUCHER** of Clarostat (on the receiving end)



... new chore on his shoulders. **COOK** of Mallory



... plays ball with us editors. **CARDUNER** of Meissner and the **ARRL'S Brunelle**



... serenity personified. **DEUTSCHMANN**, whose trademark is Tobe



... smile that doesn't wear off. **ADELMAN** of Cornell-Dubilier and "One Line Smith" of Syracuse



... explains for a serviceman. **SPITZ** of Bud with **Lew Scott** of Melrose, Mass.



... never miss shows. **HADDEN** (left) and **HAYDEN** of Ward-Leonard

... hi, pal!
HILL of Ohmite



Top Title For Throckmorton

Elected president of RCA Manufacturing after 6-months as exec. v.p.

CAMDEN—G. K. Throckmorton, since the retirement of E. T. Cunningham as president of the RCA Manufacturing Company in April serving as executive vice-president, has been elected president.

Throckmorton has been in radio since 1926, when he brought to the field more than twenty years of experience in merchandising as executive of some of the country's largest electrical concerns.

Status Quo Promise

Zenith won't alter prices, add models before new Spring season

CHICAGO—Backed up by a letter from president E. F. McDonald, Jr., Zenith home radio distributors are offering to dealers for the second consecutive year a guarantee against additional or new models, change in the present list prices of sets now included in the catalog.

Promised is refund of full dealer purchase price on any or all stock on hand should this guarantee be voided by the factory. Urged to insist that other makers follow suit are dealers in McDonald's reassuring note.

Round Robbin

New promotion idea by Emerson intriguing dealers, distributors, salesmen

NEW YORK—With the object in mind of inaugurating "Round Robbin" exchange of promotional ideas designed to sell more sets the Emerson Radio & Phonograph Corp. has started a unique new contest idea rolling throughout the trade.

Beginning October 1 dealers, distributors and salesmen were invited to submit suggestions for bettering contact between dealer and consumer, will be eligible for cash awards when the judges decide November 30. Two groups of thirty prizes are planned, one for dealers and another for salesmen.

Stancor Expands Again

New building ready by February to provide 50 per cent more space

CHICAGO—Sometime in February the Standard Transformer Corp., at present manufacturing radio parts for set manufacturers and for the trade at 850 Blackhawk St., maintaining an appliance division at 864 West North Ave., will move to a completely modernized and remodelled building providing 50 per cent more space at the northwest corner of Halstead and Blackhawk streets.

This is the second Stancor expansion in two years. In 1935 the company doubled its floor space. Two vacant lots adjacent to the building to be occupied in

February give flexibility for later additions should these be desired. Rapid growth in replacement parts business is given as the reason for this latest move permitting increased production.

LATEST DEALER HELPS

RADIO BATTERIES—Exide offers a 4-page catalog in two colors. Describes and illustrates its full line of radio batteries. *Electric Storage Battery Co.*, Philadelphia, Pa.

TUBE CHART—A new tube chart for use with the Electronometer is announced by Precision. This testing information is free to owners of series 500 and 600 and may be obtained from *Precision Apparatus Corp.*, 821 E. New York Ave., Brooklyn, N. Y.

INTER-COMMUNICATORS—The illustrations in Teletalk's large new folder show so clearly the many uses of this type of equipment, dealers will find it helpful in making sales. *Webster Electric Co.*, Racine, Wis.

NEWSPAPER—A 16-page weekly newspaper available for dealer tie-in advertising is being sponsored by Kadette for its southern market. *International Radio Corp.*, Ann Arbor, Mich.

TUBE DATA CHART—Raytheon's 11th edition of its characteristic data chart is just off the press. Contains all characteristic data. More complete than ever before. *Raytheon Production Corp.*, 420 Lexington Ave., New York, N. Y.

TALKING LETTER—Personalized mailing pieces, with the prospect's name printed on the front page, are offered by Grunow. All the dealer has to do is give his distributor a list of names and addresses and a few days later he receives the material, ready to go into the mail box. *General Household Utilities Corp.*, 2638 N. Crawford Ave., Chicago, Ill.

BATTERY LIFE—The "ABC of Radio Battery Life" designed to help dealers avoid the annoyance that results when radio batteries are misapplied can be obtained from National Carbon. A really interesting booklet, generously illustrated. *National Carbon Co., Inc.*, 30 E. 42nd St., New York, N. Y.

TUBE COMPLEMENT BOOK—Tube line-ups of practically every radio, past and current, will be found in the Sylvania's invaluable 165-page booklet. In it you will also find I. F. peaks, names and addresses of set manufacturers, trade names and lots of other helpful information. There is a charge of 25c, so be sure to include this when writing for your copy to *Hygrade-Sylvania Corp.*, Emporium, Pa.

POSTER—A 13½ x 18½ in. red and black window poster identifying the store as a service specialist may be obtained from *Supreme Instruments Corp.*, Greenwood, Miss.



PROOF—Al Gianaras, Stancor's purchasing agent, is a good fisherman, sends us this shot made while on a trip with boss Jerry Kahn to prove it



FEELS GOOD—Jack Hoffman, president of Trav-Ler, who reports the highest volume of business in this concern's history



AMATEUR PHOTOGRAPHER—That's Chester Wilcox's hobby. In between times he runs Wilcox-Gay

READRITE PRICE

**Model 430
(Correction)**

Through error, in October Radio Retailing on page 58, the price of Model 430 Readrite Tube Tester was given in one place as \$18.

The correct dealer price is \$19.80

NEW REPS AND DISTRIBUTORS

CONTINENTAL RADIO—McLendon Electric and Radio Co., Waco, Texas, new distributor for Central Texas; southern Texas goes to Straus-Bodenheimer Co. of Houston. New Colorado distributor is Leibfried Sales Co. of Denver.

GREBE—Maurice Raphael has appointed E. B. Latham & Co., New York City, as distributor for metropolitan New York, Long Island and Westchester, marking the reunion as Latham carried the Grebe line as far back as 1921.

HOWARD — Springfield Elec. Co., Springfield, Mass., is now exclusive distributor in parts of Vermont and Massachusetts.

KADETTE—Lawrence Furniture Co., New Orleans, has just taken on the Kadette line of the Intertional Radio Corp.

MOTOROLA—H. M. Tower Corporation, New Haven, Conn., has been appointed distributor in Connecticut for Motorola home radio. The Wood-Alexander Company of Hartford will continue handling automobile sets.

STANDARD TRANSFORMER—Appointed M. A. Ross, Kansas City, Mo., as representative for western Mo., state of Kansas and Ft. Smith, Ark.; granted additional territory to Roye Sales Agency, New York City, extending its travels for Stancor into Philadelphia, Delaware, Maryland, New Jersey and Washington, D. C.

AMERICAN COMMUNICATIONS—New representatives: Conrad R. Strasser, 1623 S. Hill St., Los Angeles, Cal.; J. Earl Smith, P. O. Box 1805, Dallas, Tex.; Richard Brock, 20 E. Jackson Blvd., Chicago; E. H. Christy, 542 Tchoupitoulas St., New Orleans; Hollingsworth & Still, Norris Bldg., Atlanta; Albert Leban, 27 S. Robinson St., Philadelphia; Edwards Sales Co., 942 Prospect Ave., Cleveland; Fred Stephens, 528 Macabees Bldg., Detroit; and P. A. Boyd, 312 Trenton Ave., Wilkinsburg, Pa.

WARD LEONARD—Appoints J. S. Clark, El Paso, as representative of electrical control devices for eastern Arizona, New Mexico, Western Texas. Triangle Equipment Co., New York and Chicago, will be representatives for W. L. motor starters, controllers, contactors and disconnect switches; R.

B. Anderson, in charge covers metropolitan and Jersey area; R. W. Anderson Chicago office, for Wisconsin, Illinois, eastern Iowa and northern Indiana. Southeastern Texas gets Brance-Karchy Co., Houston for electrical control devices.

UNITED SCIENTIFIC—Names Royal Eastern Elec. Supply Co., 16 W. 22nd St., New York City, and Sager Elec. Supply Co., Boston, as distributors for its Electro Call line of intercommunicators.

ATLAS SOUND—Royal A. Stemm, Chicago, new sales representative for Chicago and surrounding territory. To John O. Olson, Pittsburg, goes the western Pennsylvania area. George A. Clark, Detroit, to promote sales for state of Michigan.

TRAV-LER

..... GIVES YOU THE
OUTSTANDING SALES
FEATURE OF THE YEAR



*Automatic
Tuning in*
TABLE MODELS



TRAVEL-MATIC TUNING

An exclusive Trav-ler development. An unlimited number of stations can be logged. No tools or special keys required. Easily set from front of dial. Depressing and rotating the finger automatically tunes any station.

A complete line of radio sets having Travel-matic Tuning; carefully engineered. Housed in table models and consoles of outstanding beauty, priced in the volume brackets . . . Trav-ler offers the dealer the money-making line for 1938.

Be the first in your territory to feature these outstanding models.

Cable Address: TRAVL, Chicago



MODEL 627 6-TUBE AC-DC \$29.95

SIXTEEN MODELS—All with Automatic Tuning . . . Priced from \$29.95 to \$137.50. Ten Quality Price Leaders Without Automatic Tuning . . . Priced from \$14.95 to \$37.95.

Trav-ler Radio &
Television Corporation
1036 West Van Buren St., Chicago, Ill.
RR-1137
Please send me New 1938 Trav-ler Catalog.
Name
Address
City..... State

21

MODELS
OF *Peri-*
Dynamic
REPRODUCERS

- Every centralized sound job seems to require specially designed speakers and cabinets—but here is a complete line, the only complete line, already prepared by Jensen; for schools, hotels, hospitals, auditoriums and like uses.

- Speaker sizes range from 8 to 18 inches.
- For wall installation—Flush, Semi-Flush and Surface Mounting Styles.
- For Stage and Floor—Beautiful Cabinets, Imperial Models and more simple designs.
- Some models for voice reproduction only—many models incorporate *Bass Reflex*.
- Prices range from \$12.90 to \$310.00 complete with speakers.

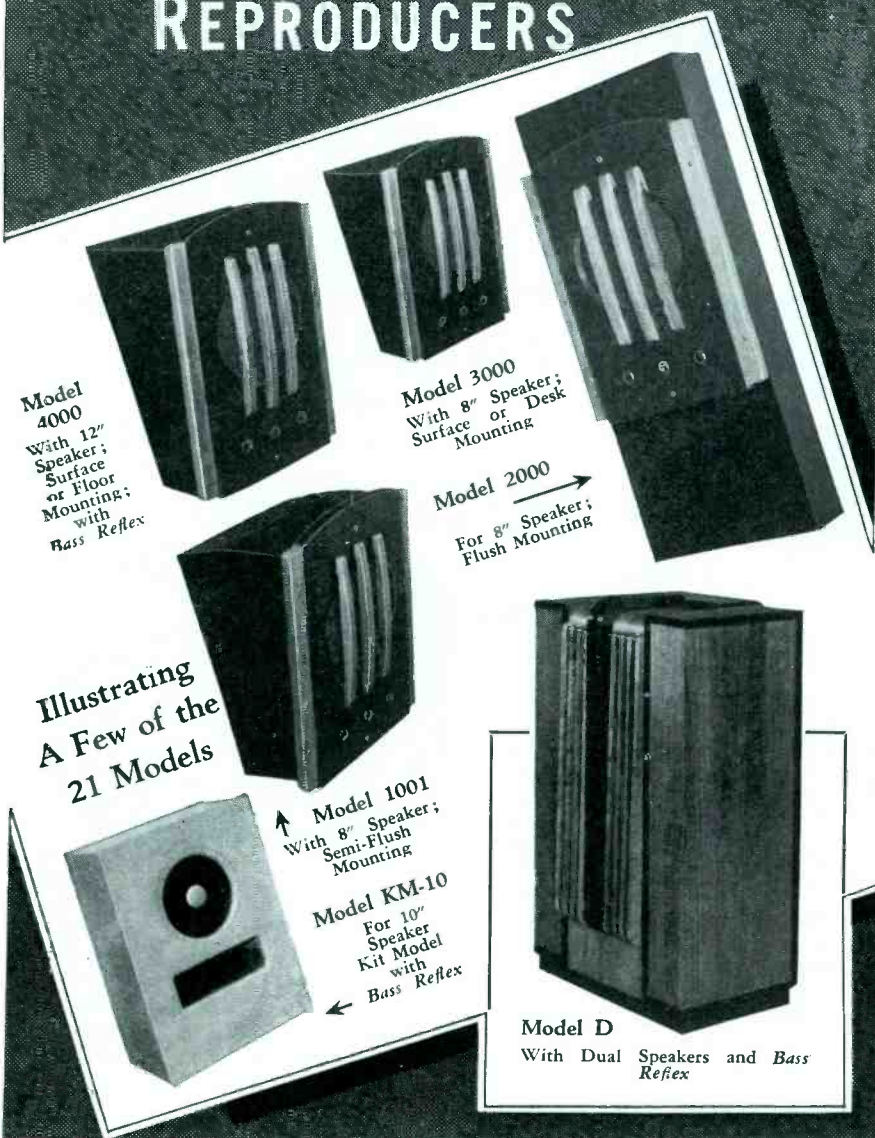

Jensen
"The Name
Insures the Quality"

Jensen Radio Manufacturing Company (RR-1137)
6601 So. Laramie Avenue, Chicago, Ill.
Please send new 8-page Catalogue describing 21
Jensen PERI-DYNAMIC Reproducers.

Name

Address

City..... State.....

The Pendulum
Swings Again
for 1938
CARS

AGAIN CROWE LEADS
with new Panel Mounting
Kits for 1938 cars! Official
styling! Attractive escutch-
eons! Softly illuminated
dials! Colored knobs! All
blending with instrument
panel of car. Airplane
and drum-type dials.
Crowe Interchangeable
Controls and Shafts
make auto radios
adaptable to any car.
Re-installation simply
by changing Panel
Mounting Kit. Get
complete details!

ASK FOR
SUPPLEMENT 204
AND
BULLETIN 202

PHILCO
DEALERS!

Crowe-Philco program
increases sale of
Philco auto radios.
Stock Crowe Panel
Mounting Kits.
Ask for Supple-
ment 204 and
Bulletin 201!

Manufacturers!

Crowe Method
of Distribution re-
duces inventory—
improves service—
standardizes prices
—simplifies selling
—stabilizes profits.
Write for details.

CROWE ANNOUNCES NEW PANEL MOUNTING KITS
CROWE
CUSTOM-BUILT

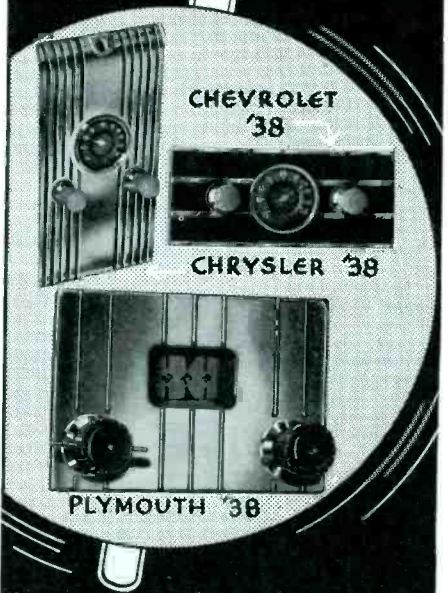

CROWE NAME PLATE & MFG. CO.
1745 Grace Street
CHICAGO, ILL.

SOUND MEN



... gave this writer mixed earful. SANDWICK of Electro-Acoustic (left) with SONDLES of Magnavox



... getting nice sound toehold. ANDERSON (center) and BLAIR (right) of Bogen with Miller of RR



... never knew we snapped it. JOHNSON of Turner mike fame



... speak the same sales language. KORBICK (wearing hat) of Webster Electric, Racine and RICH of General Industries



... now knows the ropes. O'BRIEN of Cinaudagraph



... nuts over cameras. SHURE of Shure Brothers



... busy as the proverbial hen. MECK (right) of Vocagraph



... likes selling sound, soundly. ERWOOD of Webster-Chicago



... first time we've snapped him. BRUNO (holding or being held by, mike) with GROSSMAN of Bruno



... always on deck around shows. RUTTENBERG of Amperite

RADIO COMES TO THE HILLFOLK

(Continued from page 21)

in and gave us bed and food for the night.

The Center at Vest has been in operation for over a year and the people come for miles to hear the radio. The man in charge of the set told us that many of the men-folk would come in that night to hear the "nigger fight the white man" (Brad-dock-Louis fight). Thirty-one of us, all men, listened to the fight. Some had walked as far as six miles to hear it.

Up the next morning at 3:30 and fortified by a meal of good plain food, we loaded the radio on a wagon pulled by two big red mules and started on the last leg of our pilgrimage to Elm Rock.

A beautiful June morning smiled on us as we set out on foot behind the wagon. Up Troublesome Creek we traveled to the very headwaters, over an unnamed mountain to Bald Creek, down Bald Creek to where it joins Quicksand, up Quicksand to a fork over another "hump" and down the "draw" to Elm Rock—twelve miles of boulders and 60 per cent grades through a forest primeval.

At Elm Rock we met Miss Whit-taker, who had walked 19 miles to meet us several days before. We put up an aerial and ground, uncrated the set; hooked up the battery and were ready for operation. A number of mountaineers had gathered to look at the "furriners" and see what sort of a "box" we had. Mr. Carpenter tuned the set and as the voice of the announcer came from the speaker, the faces of those clustered around showed many reactions, with unbelief predominant. In fact, one bolder than the rest said "It's got what they call a record in it. I seen one once at the 'sittlements' (Hindman, Ky.)." Mr. Carpenter tuned in 25 American broadcast stations and 14 short wave stations, some foreign. No one believed that the voices came from overseas.

We were served a noon meal of corn cakes, fried eggs (floating in grease), fried apples, and boiled beans with Sorghum molasses for sweetening.

The radio was placed in charge of a mountaineer who had spend some time in the settlements. While it was

his first time to hear a radio, he had seen them and believed in them.

We left shortly after noon, guided along a shorter trail (nine miles as the crow flies) and arrived in Vest at five o'clock in the afternoon. With aching feet, Mr. Carpenter and I drove back to Lexington and the twentieth century, happy with the conviction that we had aided in the advancement of knowledge and understanding by giving a new Listening Center to the University and opening a new era for Elm Rock.

GETTING STARTED WITH RECORDS

(Continued from page 22)

it suspended so as not to conduct sound. A rug on the floor, a comfortable chair or two, and an ashtray soon pay for themselves. Add a small table for catalogs and monthly record literature, put the hangers on the wall in trim frames.

The length of your counter (devoted exclusively to records) will be determined by your individual layout. Use part of it to display latest discs, albums, record review magazines, needles, portables and record players or other accessories. Place a sheet of heavy plate glass over the part of the counter on which change is made. Record advertisements and lists under this are in full view of the customer and often effect extra sales. Behind the counter you will want your record racks, built for both ten and twelve-inch records with larger compartments for albums. Keep the backs of your albums, like books, toward the customer. Single discs should be filed numerically in stock envelopes on which you can keep a record of purchases and sales.

Between the racks and the counter, the most important factor in your whole setup—the person who sells the records. This might be yourself or someone chosen especially for the job. Don't have an employee from another department here unless you are certain the work interests him and he knows there is a future in it. If you must go outside, get an intelligent young woman. The weaker

sex know popular tunes better than most males, are more culturally inclined. In lieu of an experienced record seller get a person who has been a record buyer. Beware, however, of the type who will "work for almost nothing just to be able to hear records." Education, but not necessarily a musical one, is highly desirable. Attention to detail is of tremendous importance in a record department. Choose someone who can take care of this efficiently, yet show executive ability, initiative and imagination. In short, put behind your counter someone who will be sure to show as keen an interest in your business and in records as you would demand a salesman demonstrating the fine points of retailing.

And now to answer the usual questions. A large stock of discs is not necessary. You do not need to stock the complete catalog of any company. Be wary of salesmen who would suggest a surplus stock of any back number regardless of its popularity six months ago. A minimum of 150 and a maximum of 500 records of one or an assortment of labels is all a basic inventory requires. You can add "standards" to this, in addition to current releases, from time to time as your experience increases. With regard to the selection of an initial inventory and its breakdown into various classifications, no one can advise you better than your local distributor. He has sales records of the best selling discs in his territory.

Take a look at your neighborhood and its possible musical tastes. College towns go big for "swing" as well as more serious fare. Music teachers will tell you about the town's musical activities, the people who support them. Query your radio customers as to the kind of music they prefer, what programs they like best. That's also an excellent way to introduce them to new records of their favorite music, and perhaps a phonograph or combination sale.

Your record inventory should have a sixty-day turnover. Items which you can't sell within a three-month period aren't worth shelf space. How to keep from overstocking is the subject for next month's article.

As for your inventory of phonograph instruments, record players, portables and combinations, your last year's radio gross is your best index.



Why not sell a line that's DIFFERENT

That's STANCOR: the COMPLETE, COMPACT, COMPETITIVE line. It's COMPLETE because it covers the greatest range of transformer requirements with the fewest types . . . COMPACT because "dead-wood" has been eliminated . . . COMPETITIVE because it's COMPLETE, COMPACT and so conservatively priced. • It's different because a stable price policy protects everyone who buys or sells it • It's different because it is supported by active field merchandising that makes it the "livest" line on anybody's shelf • Get the full story on the STANCOR line. It's Different.

**S T A N D A R D
T R A N S F O R M E R
C O R P O R A T I O N**

850 BLACKHAWK ST. • CHICAGO, ILL.

RADIO RETAILING, NOVEMBER, 1937

IT'S HERE!
Push Button Condenser Tuning at the Right Price



**FOR THE FIRST TIME--
PUSH BUTTON TUNING AT A**

SENSATIONAL LOW PRICE

**ONLY
\$22⁹⁵
RETAIL**

MODEL A-48 IN STRIPED WALNUT

- Automatic Electric Tuning
- FIVE Working Tubes
- NO Ballast Tubes
- Automatic Volume Control
- Continuously Variable Tone Control
- Superb Tone Quality
- Extremely Smart and Compact
- Superheterodyne Circuit
- Dynamic Speaker
- Fully Licensed

CHECK the price with the above features and see if you can find anything that even compares with this amazing value. This is what you have been looking for—a value so great it's out in front—ahead of the crowd creating new sales enthusiasm everywhere . . . because, never before has such value been offered in radio.

Designed and built by Wilcox-Gay engineers to fill the need of automatic push button electric tuning at the right price, this new and attractive receiver offers distributors and their dealers the most salable piece of merchandise on today's market. A beautiful cabinet of different wood combinations adds to the eye appeal of this startling value.

Decide now to put that added punch in your holiday sales by offering your customers this radio which sells itself and answers the national gift problem.

This model and 14 other precision built receivers are packed with every worthwhile feature; and combine to make the Wilcox-Gay line, leader in the most radio value per dollar of all time. Here is the opportunity to sell merchandise that will make you money and build good will for future business. Ask your distributor or write us today.

Full line of export models available for foreign distributors.

WILCOX-GAY CORPORATION
CHARLOTTE MICHIGAN U.S.A.

CREDIT TERMS

(Continued from page 33)

his income during the life of the instalment contract will be far greater than the amount of cash he has available today. Furthermore, he realizes that he can keep his cash for other uses *and still own the radio*.

Instalment purchasing is simply another form of saving. The time buyer generally gets something worthwhile for his money but since cash has so many uses it is awfully easy to dissipate cash savings intended for the radio purchase in the pursuit of other pleasures. Instead of *cash and the radio* many prospects end up with neither.

Instalment selling which made good in the automobile industry long before the advent of the radio has proven its worth to the radio industry. It has permitted mass production and given us lower unit costs. Sales only go up thru a wider use of instalment selling. Instalment companies supply the retailer with stocks of merchandise from the factory and then act as the accessory to the sale of the merchandise to the consumer. They relieve the dealer of the responsibility of passing credits and making collections and give him more time for selling.

The only danger in the system is the over-enthusiasm of dealers and their salesmen to sell *long terms instead of terms* and "no down payment" instead of seeing to it that the purchaser pays enough down to feel that he has an equity in the product. The general agreement between the leading banks, finance companies and retail merchants that this is a good time to soft-pedal should be warning enough to those who seem more interested in big business than in big profits.

RECIPE FOR SELLING REFRIGERATION

(Continued from page 37)

stead when prospecting for more customers in that area.

Telephone canvassing and direct mailings come next in the dealer's favor—about 22 per cent using these forms. Next in order come newspaper advertising, cooking schools (always a prolific source of prospects), recipe folders, food cost charts, and some form of door-opener.

As we mentioned before, of course, local radio advertising is proving an increasingly profitable way for dealers to locate prospects.

The Composite Dealer

Using this survey as a basis, we might say that the average successful refrigerator dealer (and remember that he carries other lines besides refrigerators!) operates in a town of 28,452 population, located in the Middle West. His store is located in the middle of the block in a downtown shopping center. He started in business in 1918, began selling refrigerators about 1932, and at present handles one line. He employs seven salespeople all together—four of them on refrigerators. Two of these salespeople sell refrigerators exclusively. He holds a sales meeting once a week; advertises in the newspaper fairly regularly and makes liberal use of the manufacturers' sales material. He sells about 70 refrigerators a year at an average price of about \$185.

What has been said above might apply with equal force, with slight variations here and there, to other appliance lines—washers and ironing machines, ranges and water heaters, oil burners and automatic coal stokers. Granted the differences in selling technique required for different types of products, the same essentials of manpower, store location and display, advertising, financing and service, form the basis for diversification into other lines.

We have talked about seasonal selling and ironing out the peaks and valleys in the radio business before. There's nothing new to be said on the subject. But it's the same old headache to the radio dealer with a functioning organization on his hands—and not enough for them to function on in the good old summer time.

"Well, that don't sound so bad," the dealer said. "I got the store, a sweet location, and guys who call themselves salesmen around here. I call 'em something else but that's neither here nor there, as the feller said."

"You're all set," the man said, poking him in the ribs again.

"Wait a minute, though," the other man said. "I haven't been in this radio business for nothing. What you tell me is all the good part. We got a good part to our business, too. But we've got another side. Did you ever hear about trade-ins? What about service? How about these

guys that want to chisel the bread-and-butter out of the mouths of your children? . . ." He pushed the "Marked Down" sign a little further behind the radio set. "What about margins? What about advertising allowances? You got an answer for those?"

"Sure", the man said. "You have them all in the radio business, don't you. Plus some of the keenest competition you can find in any business. And you're still in business, aren't you? And doing more radio business than any of your competitors? There's your answer."

A great light broke on the other man.

"I get it", he said. "Let's take a crack at these refrigerator boys."

HOLIDAY WINDOW

(Continued from page 41)

ter the slogan on the cardboard. Gold and bright red should be the principal colors on the slogan strip. Again, if you have plenty of other cards and displays to carry your copy, a small Christmas tree may be placed where the right-hand perpendicular panel stands in the illustration. Also, for the sake of economy, the cut-out village may be eliminated. Instead of the village bank up snow to the bottom of the sky line. Of course, it is needless to say, the row of quaint houses adds much to the effect. Christmas trees, wreaths, Santa Claus and other standard Christmas trimmings may be used to complete the window ensemble, according to size of the window and your taste.

Be sure the lamps in the shadow box are brilliant enough to snap out the light through the tontine cloth and gauze. If necessary, 100-watt lamps may be placed in circuit. Do not go above that wattage as the flasher box is not rated higher. The heat generated by the larger size lamps need not be taken into consideration as each is on only three seconds and off about twenty.

The slogan is very important, and should be given plenty of prominence by position and colors—but not with over-large lettering. Fasten the sky section close to the shadow box, and use tape if any light seeps through cracks.

The eighth flash is wired to the lights behind the village, and not as was set up in the October display. That is the only change in the electrical equipment to be made.

Get the *"Inside Story"*
before you buy any instrument!



WESTON Model 775 Serviset, which consists of Model 772 (20,000 ohms-per-volt) Analyzer—and Model 773 Tube Checker.

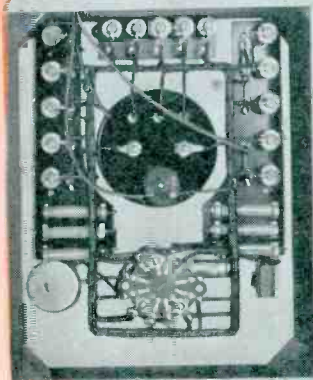

An inside view of the Serviset... above, Model 772... below, Model 773.

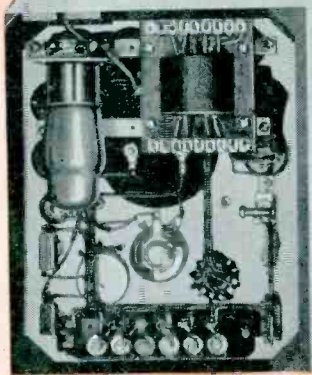

Buy instruments as you would buy a radio set. See what's inside! *Examine the quality of every single part. Carefully inspect the workmanship. Check the fundamental design.* These are the factors which determine the accuracy, dependability and service life of an instrument . . . and should be your guide when buying any test equipment.

After checking the *inside* of the two WESTONS shown above in the combination case . . . instruments also sold singly . . . remember that these instruments give you the following outstanding operating features:

MODEL 772
Analyzer

All AC readings on single AC arc
Simplified, easy reading scale .
Decibel readings for sound measurement .
Current ranges for auto testing .
New rectifier circuit .
Improved accuracy .
Improved temperature coefficient .
Big 50 microampere WESTON meter . . .

MODEL 773
Tube Checker

Individual emission test, each element .
Individual short test, each element .
Noise test, each element .
Cathode leakage test .
Short test while tubes are hot .
Tubes tested under proper load .
Wired for changing filaments .
Flexible switching arrangement defeats chokescence.

Send coupon for complete details

WESTON
Radio Instruments

WESTON ELECTRICAL INSTRUMENT CORPORATION

581 Frelinghuysen Avenue, Newark, N. J.

Send full data on all Radio Instruments

Name _____

Address _____

City _____ State _____

QUIET

**SILENT
SPIRAL
CONNECTOR**

PATENTS APPLIED FOR



**5-FINGER KNEE
ACTION ELEMENT
CONTACT**



Metallized **TYPE
VOLUME CONTROLS**



IRC HAS SPARED NO EXPENSE SO THAT YOU CAN BE SURE

Study the design of IRC Metallized Controls. Note in particular the precision construction of the 5-Finger "Knee Action" Silent Element Contact and the new Silent Spiral Connector.

Each of these exclusive features means thousands of dollars in research by IRC engineers. Each means additional manufacturing expense—yet IRC Controls cost you no more than ordinary controls having neither of these noise-eliminating features.

It is "plus" values such as these that have made IRC resistance products famous the world over. By giving you the greatest value for your money, by doubly insuring you against customer complaints, we protect our reputation by helping you protect yours. That is good business for both of us!

Silent Spiral Connector available on IRC Special Replacement Controls listing at \$1.50 and up ... designated in Guide with prefix "J".

5-Finger "Knee Action" Silent Element Contact supplied on all IRC Controls.

INTERNATIONAL RESISTANCE COMPANY

401 NORTH BROAD STREET, PHILADELPHIA, PA

Factories or Licensees in Canada, England, France, Germany, Italy, Denmark and Australia

**MAKERS OF RESISTANCE UNITS OF MORE TYPES, IN MORE SHAPES, FOR
MORE APPLICATIONS THAN ANY OTHER MANUFACTURER IN THE WORLD**

TECHNICAL

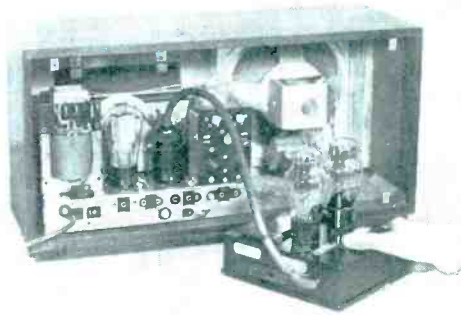
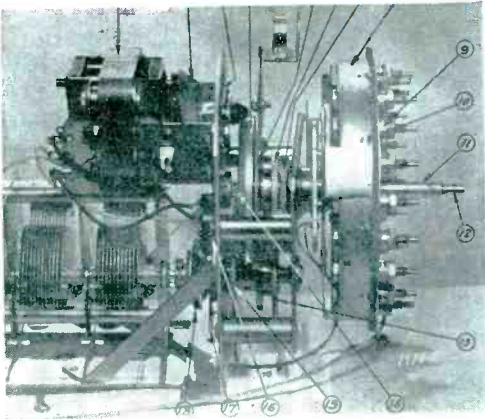

RADIO

Extra winding in novel, new tuning motor eliminates noise between stations.

TESTERS

German device compares old tube with new, uses receiver's own circuits for power.

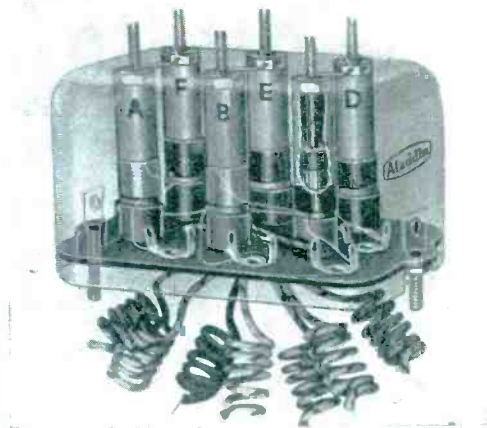
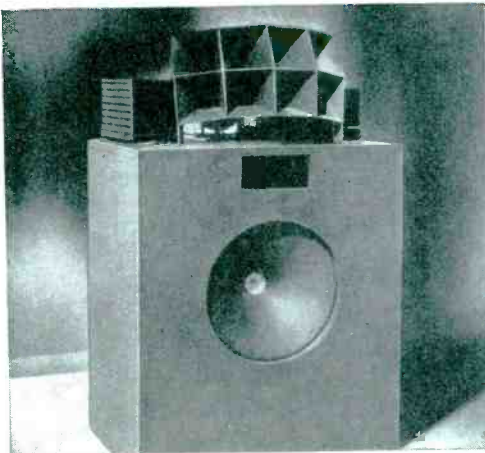

SOUND

Combination high-frequency multicellular horn and low-frequency unit gives 10,000 cycles, 80° coverage.

PARTS

Oscillator coils grouped in one housing for increasingly popular pre-selected tuning.

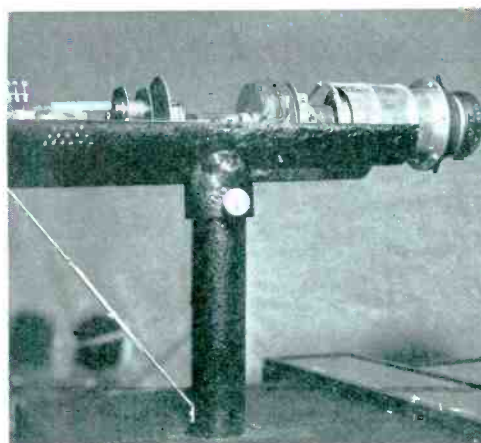
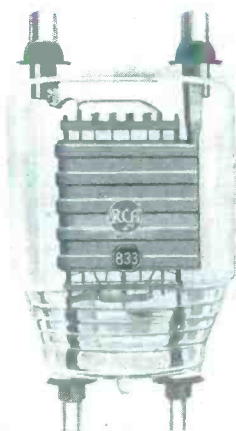

TUBES

High efficiency at high-frequencies, with short, heavy leads, tantalum plate.

TELEVISION

Projects picture on 3 by 4 ft. screen, uses electro-magnetic deflection.

PROPER INSTALLATION



CORRECT SPEAKER POSITION—A satisfactory setup for a small installation. Notice speaker baffle placed at right angles to microphone to reduce feedback.

WITH the advent of a greater consciousness on the part of the public for proper sound reinforcement, it has become increasingly important that sound systems properly fulfill this requisite and deliver the proper amount of reinforcement, as well as proper tonal quality. In the past, the average system was merely capable of producing sound at a more or less unknown level and with little regard for complete sound coverage or correct distribution of sound to cover all parts of the auditorium, room or area equally well. Such systems failed to fulfill their purpose and created a somewhat negative reaction on the part of the audience. These systems were installed without any regard for the fundamental principles of acoustics and without any knowledge of the manner in which sound radiates from the reproducing source or how sound is reflected from surfaces, in what proportion it is absorbed, and without consideration to the relative absorption of the various parts of the frequency spectrum.

Necessary Frequency Range

Let us first consider the problem of simple reinforcement of speech exclusive of music where the band of audio fre-

quencies which must be reproduced and distributed is comparatively narrow. It must be remembered, however, that speech actually covers a wide band of frequencies, but ordinarily does not require consideration of the entire band width for highly intelligible and satisfactory sound coverage. In such cases the reproducing system should respond satisfactorily to frequencies from approximately 100 cycles to 4000 cycles and preferably to 5000 cycles. There are on the market today many types of reproducing units, which will fulfill this requirement without the use of two separate units, each reproducing only a part of the entire band of frequencies. This latter type presents a somewhat greater problem for proper installation with consideration for space requirements and enhancement of distinctive decorative schemes which are found in many places today. The single unit can be fitted in more easily at a less conspicuous point in the room and offers, therefore, a greater amount of flexibility in establishing a compromise between the ultimate in results and the practical compromise. Similarly, the proper reinforcement and reproduction of music presents practically the same problem except that musical tones cover a wider band of frequencies than speech

By

J. R. Poppele

Chief Engineer, WOR

and the upper limits of the band require greater consideration than in the case of speech reproduction. Musical tones also comprise a more complex wave form and reproducing units not capable of proper reproduction of the frequencies in the upper range of the audio band, of necessity omit the all-important overtones without which fidelity of tone is impossible.

Basic Problems

In the Sound Field today we encounter many kinds of applications of sound reinforcement each of which presents its own individual problems. There are, however, basic principles which can be applied in all of these installations. There have been installed in the past few years numerous systems in auditoriums, restaurants, ballrooms, clubs, churches, studios and stores. Numbered among the special applications, we might mention several music towers in cemeteries, paging systems and studio installations for advertising agencies. Since the matter of proper amplifying equipment has been quite fully covered in numerous works, let us merely consider the fact that amplifiers must have a satisfactory frequency response and be of rugged construction to withstand many hours of continuous use without undue maintenance requirements. There are many types, of various design, produced by leading manufacturers which are reasonably priced and which will deliver satisfactory results for long periods of operation. Consideration must be given, however, in the selection of an amplifier, to the requirements of gain, power handling capacity and other important factors related to the particular installation being considered. It is a common fault in the selection of equipment to provide an amplifier capable of 50 watts audio output when the installation may require as little as 15 watts and an equally common fault to select an amplifier which is not capable of delivering sufficient power to the loud speakers and must, therefore, be operated beyond its capacity, resulting in serious distortion.

Power Required

The engineer planning the system must first of all know the amount of sound energy required, the efficiency of

OF SOUND SYSTEMS

the speakers being used, and can then calculate amplifier output requirements and intelligently and economically select an amplifier best suited for the particular job. (See Sound Installation Chart, Page 83.) Similarly we must know the output level of the microphones, or mixing system, in order to recognize gain requirements of the amplifier. A common fault of many installations is improper impedance match both on the input side of the amplifier as well as on the output, particularly, where the installation consists of numerous loud speakers. It is needless to say that the microphone which is the heart of the system must be capable of high fidelity and must be suited to the installation with respect to directional properties and the particular acoustics of the room.

Acoustic Treating

In broadcast studios, it is quite possible to realize a high degree of perfection in acoustic balance, which is usually in direct contrast to the conditions encountered in most places where sound reinforcing systems are required. Since acoustic measurements are, in many instances, beyond the realm of possibility on small inexpensive installations, the engineer must use good judgment in whatever correction of acoustics is possible. Measurements will, of course, determine exactly the reverberation time, resonance at certain frequencies and other important factors which have utmost bearing upon the sound reinforcement problem and it is recommended that these measurements be made wherever possible, particularly on the large installations. Equipment for this purpose has been developed to a very refined stage and such service is available commercially from various research organizations and consultants. In the case of the larger installations, the cost of this service is small in proportion to the total cost of the system and a complete knowledge of the acoustic factors with which we must deal will allow us to handle the problem more intelligently.

If acoustic treatment becomes necessary, there are a number of satisfactory materials available on the market, but it is extremely difficult to know the amount of surface which must be treated or the proper point at which the material should be placed to secure best results. We must bear in mind that the problem is not to develop surfaces which will simply absorb all of the higher frequencies and at the same time have little or no effect on the low and intermediate frequency range, but to ad-

just the acoustics so that we will have proper sound transmission of the entire band of frequencies which is to be handled. The realization of this fact to the fullest extent requires an acoustic engineer with considerable experience. The proper installation of acoustic material is equally important and it is recommended that this type of work be handled by a thoroughly experienced contractor who specializes in the work.

Naturalness

Many sound installations deliver what might be termed satisfactory coverage of the room or auditorium, but fail to create the proper illusion that the sound is coming from the source rather than from the reproducing units. A common fault is to use numerous

loud speakers operating at a comparatively low level instead of centralizing the projection of sound and operating the speakers at a higher level. It is an established fact that when more speakers are used, it becomes an even greater problem to properly place them and still retain the correct illusion. In contrast, the method of centralizing projection presents the problem of having too high a level of sound at the end of the room nearest the speakers in order to obtain sufficient sound at the far end. Figure No. 1 shows a typical layout and an attempt will be made to show very briefly some of the advantages and disadvantages of various placements of speakers. The reproducing units used are assumed to have a very poor directional characteristic and,

(Continued on page 86)

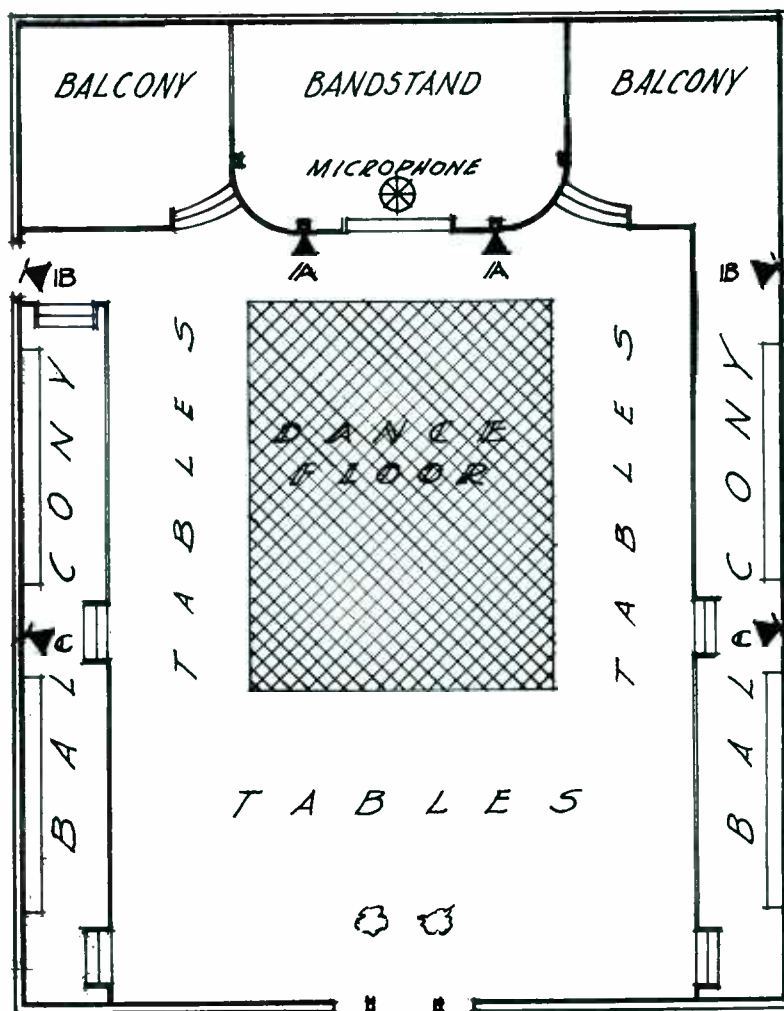

TYPICAL LAYOUT—Natural sound illusion is obtained only by proper speaker placement (see text).

Bill - the
 This is the
 oscillator I spoke
 of to you about
 It's a honey
 JAMES SMITH
 RADIO SERVICE INC.
 2024 MAIN STREET
 CITY
 PHONE
 RAD. 1034

★ ACCURACY ★

Guaranteed In This Low Price Signal Generator

★ Wherever you go you will hear praise for Model 557 Direct Reading Signal Generator. Continuous use day in and day out has clearly demonstrated its remarkable accuracy and reliability.

Model 557 Direct Reading Signal Generator uses plug-in type coils. Five frequency bands are covered from 110 to 20,000 K.C., all fundamentals. Completely shielded for static and magnetic fields. Attenuation and stability are outstanding features. Strong signals both modulated and unmodulated are furnished.



Each individual coil is separately calibrated by an exclusive method of peaking with trimmer condensers. Furnished complete with batteries and accessories.



EXCLUSIVE RANGER EXAMINER DEVELOPMENT

Model 557 Complete DEALER PRICE

1% Accuracy to 3,000 K. C. • 2% for Higher Frequencies • Range 110 to 20,000 K. C. Only \$18.90

<p>1938 Up-to-the-Minute Tube Tester</p>  <p>Model 430</p> <p>\$19.80</p>	<p>Combination Volt-Ohm-Milliammeter and Free Point Tester</p>  <p>Model 640-740</p> <p>\$28.35</p>	<p>Foundation Oscilloscope with Built-in Sweep</p>  <p>Model 840</p> <p>\$11.40</p>
<p>Five flush type sockets provide for all tubes. The tester operation is very simple and indicates condition of the tube for dealer and customer on Direct Reading (GOOD-BAD) colored scale of Triplet instrument. Will also test for inter-element shorts and leakages. Complete in attractive, sturdy, quartered-oak case. Sloping etched panel of silver and black. Suitable for portable or counter use.</p>	<p>Precision built throughout, Readrite-Ranger Radio Testers need no apology from the highest class servicing shops. In fact, you will find them using these rugged testers on calls because they have been particularly designed to withstand rough field work. Ask your jobber to show you today's values in precision radio testers.</p>	<p>LESS TUBES</p> <p>A practical foundation unit for amateurs, engineers, sound and radio servicemen. With proper external additions, it offers facilities for the study and adjustment of countless circuit problems. May be adapted for R.F. and I.F. alignment, resistor, condenser, vibrator and many other tests.</p>

TODAY'S BIGGEST VALUES IN PRECISION TESTERS



READRITE METER WORKS
 1120 College Drive, Bluffton, Ohio

.....Please send me more information on Model 557;.....

.....Model 640-740;..... Model 840.

Name

Address

City State

SOUND INSTALLATION CHART

Relation between amplifier output and size of auditorium.

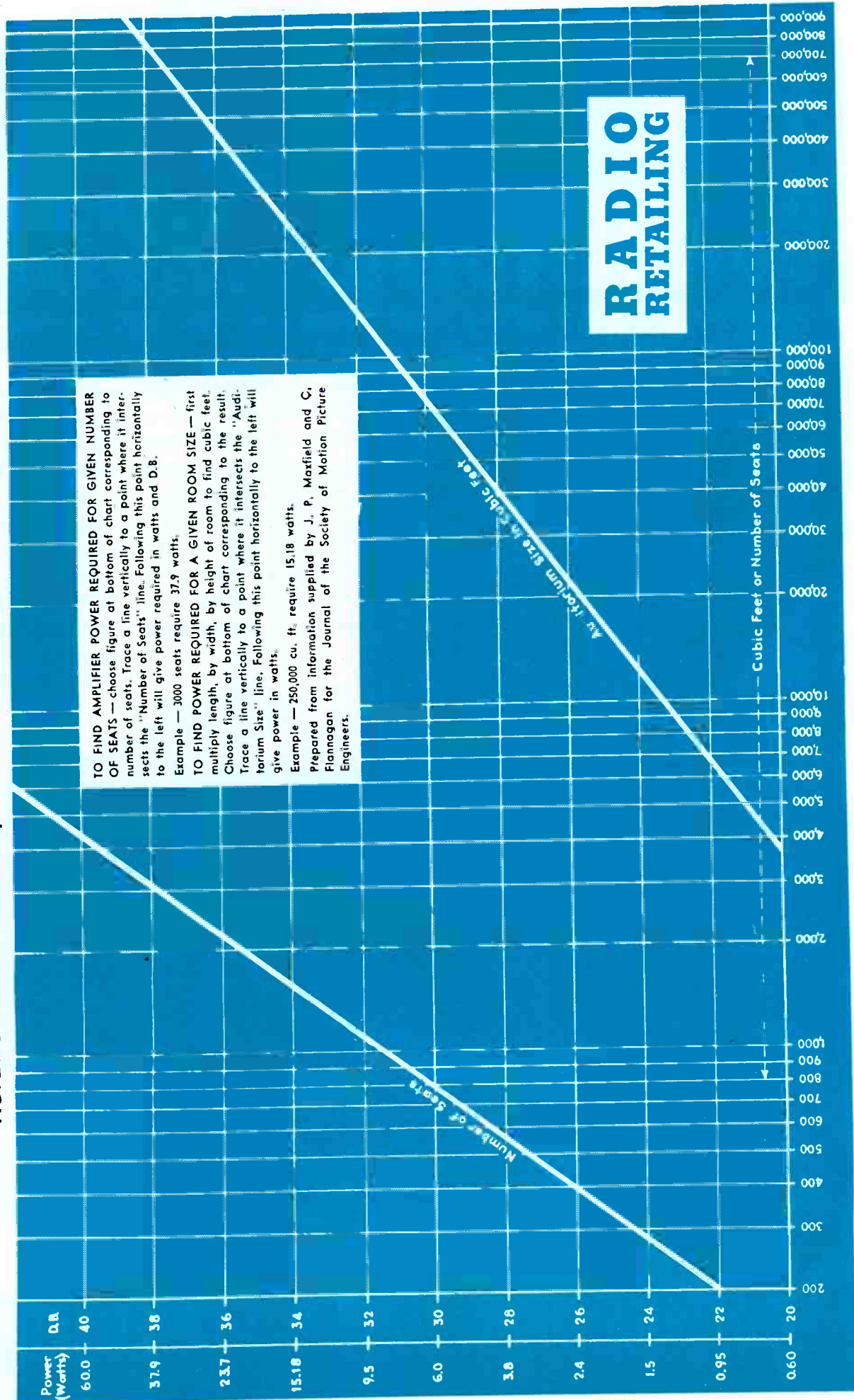

**RADIO
RETAILING**

NOW! NATIONAL UNION CONDENSERS *ELECTROLYTICS* and *PAPERS*

New N. U. Plus Profit Products for Radio Service Experts

HERE'S SENSATIONAL good news for Radio Service Specialists! The same superior quality . . . the same plus profit opportunities which make NATIONAL UNION RADIO TUBES outstanding choice in the Service Profession are here in this new line of Condensers. NATIONAL UNION has spent years working . . . building with you. National Union knows the kind of merchandise you demand. It is here in these new condensers with built-in quality and guaranteed performance. The chance to build your business bigger and faster is here too. Get details from your distributor today. Start now to cash in on N. U. Condensers as well as N. U. Tubes.



**REMEMBER!
YOU CAN GET
FINE SHOP EQUIP-
MENT FREE THE
EASY N. U.
WAY**

GET DETAILS FROM YOUR N. U. DISTRIBUTOR!
OR WRITE
NATIONAL UNION RADIO CORPORATION, 570 LEXINGTON AVE., NEW YORK CITY

How To Install and Service

Phono-Combinations

By H. D. Hooton

THE majority of the better class of radio receivers sold today have some provision, usually a jack at the rear of the chassis, for the connection of a phonograph pick-up. In converting these sets for phonograph reproduction, the problems involved are comparatively simple; it is only necessary to add a turntable and motor and plug in the pick-up. The small inexpensive sets, on the other hand, often tax the ingenuity of the service man to the utmost; almost every type of circuit from the regenerative to the superheterodyne is encountered, each with its own individual problems to be solved. As the service difficulties are not greatly different from those ordinarily encountered when making an original installation, this will deal mostly with installation problems.

The first step is to decide to which part of the radio receiver it will be best to connect the pick-up. In the average small set with only one audio stage following the second detector, the gain is usually too low for satisfactory volume. In cases of this kind,

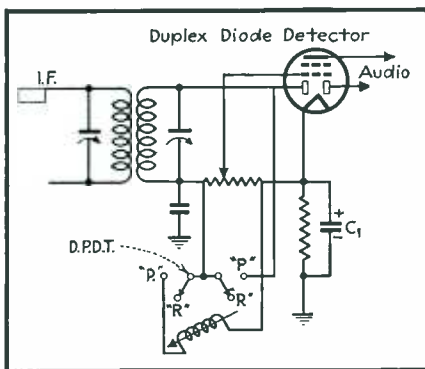

Fig. 2. Schematic details for connecting pickup to duplex-diode detector

it is best to place the pick-up in the input circuit of the second detector itself, which means that the "radio-phono" switch must be arranged to remove the high bias as well as the radio signal from the detector grid and to cut in a resistor of the proper value.

Connecting to Detector

Care should be exercised when connecting a pickup to an average detector because the signal if fed into the highly-

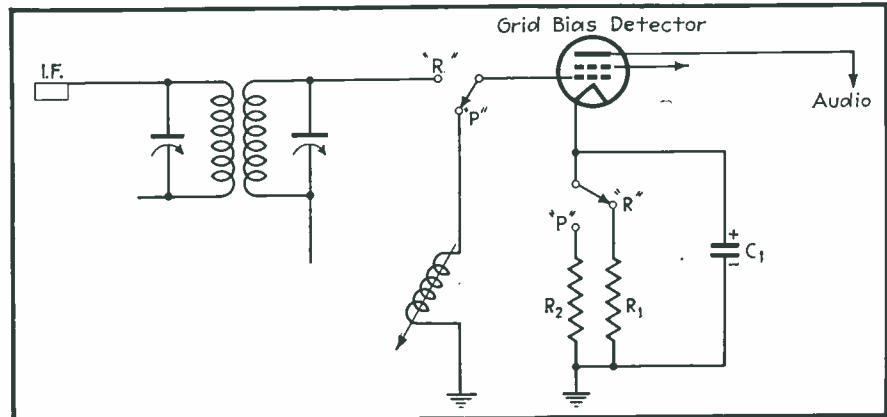

Fig. 1. Circuit showing how grid bias detector may be converted to work as additional audio amplifier in low gain sets

biased detector will be distorted. Several typical circuit arrangements for feeding the pick-up voltage to the detectors commonly employed will be considered.

Figure 1 shows how the connection is made to a detector tube using the grid-bias method of detection. It will be noticed that two separate bias resistors are used to obtain the proper operating conditions for either phonograph or radio reproduction. When the D.P.D.T. switch is thrown to the "R" (radio) position, the pick-up is disconnected and the secondary of the I.F. transformer is connected to the grid of the tube as shown. As illustrated, the low-bias resistor, R2, is simultaneously cut out of the circuit and the high-bias resistor, R1, is connected to the cathode. The circuit conditions when the switch is placed in the phonograph ("P") position are obvious from an examination of the diagram. The electrolytic condenser, C1, should be connected to the switch arm as shown and not across either of the resistors; if placed across the resistor, it will be necessary to use two separate condensers (or a dual) in order that the proper by-passing will take place in each position of the switch. The value of the low-bias resistor, R2, may be calculated by dividing the bias voltage desired, by the plate current of the tube. Thus if 25 volts of bias is desired, and the plate current is 30 milliamperes when the bias is applied, then the value of R2 will be 25 volts divided by 0.030 amperes or 833 ohms. If the tube has a screen or other grids drawing current,

these currents must be added to that of the plate circuit before making the calculation.

Most of the modern superheterodyne receivers employ duplex-diode triode or duplex-diode pentode tubes as second detector, AVC and audio amplifiers. Connection to many of these circuits is quite simple. A typical circuit is illustrated in Fig. 2.

Controlling Oscillation

When feeding the pick-up voltage to this type of circuit, however, care must be exercised to keep the leads from the grid to the volume control and switch as short and direct as possible in order to avoid oscillation or instability in the audio amplifier. In some receivers, especially those in which high-gain audio amplifiers are employed, it may be necessary to shield all of the input leads to the audio tubes before stability can be secured. If this does not eliminate the trouble,

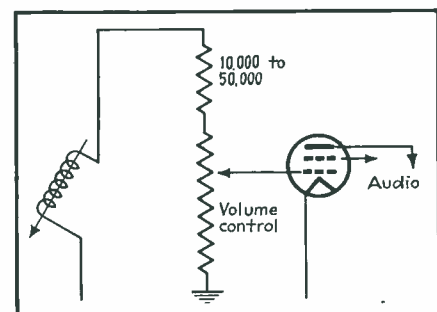

Fig. 3. Simple method for curing audio oscillation

any remaining instability can usually be removed by placing a small carbon resistor of from 10,000 to 50,000 ohms value in the input circuit of the first audio stage as shown in Fig. 3. The resistor should not be used unless the shielding fails to clear up the difficulty. It goes without saying that in all cases where audio oscillation is encountered, the by-pass condensers, especially the electrolytics, and the de-coupling filters, if these are employed, should be checked before making any kind of changes in the circuit itself. It has found that in many instances the trouble was due to this cause even though the radio signal came through satisfactorily before the phonograph installation was made. In the majority of cases where oscillation is found, motor-boating or other difficulty will be encountered when the switch is thrown to the radio position due to the extended wiring and the capacity of the switch. The service man must have patience when working with troubles of this kind; if the oscillation cannot be eliminated, it is quite likely that sufficient volume will be obtained by feeding the pick-up voltage to the second audio stage. If the gain is high enough to cause instability, there is almost certain to be consid-

erable amplification in the following stage.

In the circuit shown in Fig. 2, the radio volume control is also the phonograph volume control. In other circuits using the grid-bias method of detection, the radio volume control is

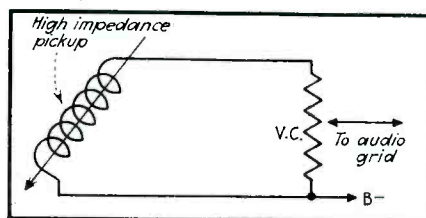

Fig. 4. Volume control method for sets using r.f. gain control

usually connected somewhere in the R.F. end of the set. Obviously, since the pick-up voltage is fed to the audio amplifiers, the R.F. control will have no effect whatever on the phonograph reproduction. In cases of this kind, if the pick-up does not have a built-in volume control, it will be necessary to provide an external control which may be built into the radio chassis or installed somewhere near the pick-up itself. If the pick-up is of the high-impedance type, the volume control may consist of a potentiometer connected directly across the pick-up

windings as shown in Fig. 4. The exact value of the resistance will depend somewhat upon the impedance of the particular pick-up in use; common values are from 50,000 ohms up to $\frac{1}{4}$ or $\frac{1}{2}$ megohm. When the low-impedance type of pick-up is used, an impedance-matching transformer must be utilized to effectively transfer the voltage to the amplifier. In this case, the volume control may be connected across the secondary of the transformer as shown in Fig. 5. In the foregoing discussion and illustrations, it has been assumed that the pick-up windings are of the high-impedance type; the connections to low-impedance units are exactly the same except for the matching transformer. In low-impedance pick-up installations the transformer will replace the actual pick-up windings.

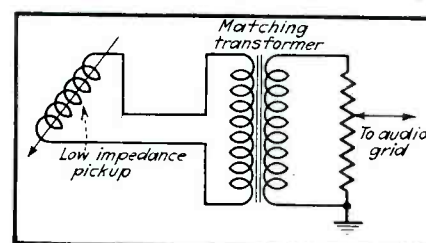

Fig. 5. Connection of volume control for low impedance pickup

SOUND INSTALLATION

(Continued from page 81)

therefore, cover a wide angle of radiation. The characteristic, of course, changes gradually over the band of frequencies being reproduced since the higher frequencies have a tendency to radiate in a narrower beam than the lower frequencies. The effective balance between the various parts of the audio band will, therefore, vary in different parts of the room, but this condition cannot be corrected successfully by any simple setup.

Placing the Speakers

Placing the speakers at positions A will give somewhat better coverage of the front center portion of the room with a slight sacrifice in sound level at the rear of the room. This setup, however, will create the proper illusion for the listener in that the sound will appear to come from the original source. By placing the speakers at positions B, it may be possible to secure somewhat better coverage in the opposite rear corners of the room since a greater portion of the sound will reach these points direct rather than by reflection from the side walls. The illusion, however, becomes poorer and the effect in general is not so real as produced by placement at A. If the two speakers were left at points B and two additional speakers were used at points C, the reinforcement over most of the room might be improved, but the illusion

would be even poorer than with the two speakers alone at points B. Likewise, using two speakers at points A and two speakers at points C would not retain the proper illusion. We have assumed in this discussion that there are no unusual acoustic factors and that all speakers are properly phased. It is assumed also that the size of the room is such that the time interval for sound transmission is negligible for all practical purposes. In most installations, however, it is customary to encounter unusual acoustic characteristics which require careful handling in order that the final result approaches to some degree at least the perfect installation.

Location of Equipment

Probably next in importance is the proper placement and installation of the amplifying equipment. This part of the system should be properly housed and located at a point where it is readily accessible from an operating and maintenance standpoint and at the same time is not conspicuous and subject to tampering and damage. The combined unit should be locked with only the main volume control and mixing system, if used, exposed for convenience of operation. The system should be in charge of some one competent person who can be thoroughly instructed on its proper operation and made responsible for the care and maintenance. All wiring should be installed in accordance with Fire Underwriters Regulations and the installation should be made by persons who are acquainted with the require-

ments of sound systems and who will know proper types of wiring to use for the various parts of the system and be conscious, for example, of the necessity for shielding all low level wiring. At the same time, the economical angle must be considered in order that the final cost of the system will be in proportion to the effective value to the owners of the establishment. The owners should be sold on the necessity for maintaining a reasonable supply for spare vacuum tubes, fuses and other essential units. It must be remembered that the system is an essential factor in the operation of the business and must be maintained in operating condition at all times. The person who is to be responsible for the operation of the system should be carefully instructed in a systematic schedule of maintenance in order that all parts of the system may deliver this peak performance at all times.

Sound an Investment

If we can show that sound reinforcement is necessary in any business establishment, it should be an equally simple matter to show that a sound investment in an amplifying system is good business, and, if compared over a period of years with a cheaper and less efficient system, will show a definite saving. Statistics available show that the cost of good sound equipment is in the final analysis a negligible portion of the total operating expense of any business. It saves time and money to use good equipment.

Build Farm Battery Business with **GLOBE!**

A COMPLETE LINE for EVERY RADIO and Light Requirement

Thousands of people who live away from "Power lines" will buy radios and light plants this year. And each must purchase one or more batteries.

The new Globe radio and light batteries offer dealers an unusual opportunity to build a profitable and lasting battery business. There is a Globe high efficiency battery to meet every power and light requirement.

When you sell Globe you sell a complete line of radio, light and automotive type batteries, with 8 factories and 4 warehouses reaching from coast to coast ready to make immediate delivery. Globe national advertising carries the Globe story to millions of your prospects.

Send for new Bulletin 87-A to learn all of the facts about Globe Radio and Light Batteries. Just clip the coupon.

GLOBE-UNION INC., Milwaukee, Wisconsin

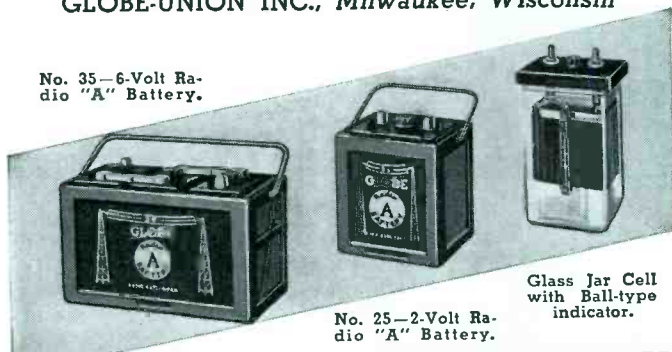

No. 35—6-Volt Radio "A" Battery.

No. 25—2-Volt Radio "A" Battery.

Glass Jar Cell with Ball-type indicator.

GLOBE-UNION INC., Milwaukee, Wisconsin
Rush Bulletin 87-A and full details
about Globe radio and light batteries.

Firm Name.....
Street.....
City and State.....
Individual..... RR-6



IF YOU CAN ANSWER "YES" TO THESE QUESTIONS

1. Have you an established radio service business?
2. Is your location free from interference with already established Tung-Sol agents?
3. Have you the necessary technical knowledge and equipment to service radio?
4. Is three months' supply a sufficient tube stock?
5. Will you agree to make a monthly stock report on standard forms provided by the wholesaler?
6. Will you regularly use display and advertising material furnished by us?
7. Will you maintain Tung-Sol established retail prices?
8. Have you sufficient capital to meet your obligations promptly when due?

If you can answer "Yes" to these questions, Tung-Sol has a Consignment Plan that will show you better and quicker tube profit than you ever thought possible.

Look the questions over—and if your answers are "Yes"—WRITE TODAY for name of your nearest wholesaler.

PLEASE ADDRESS DEPT. B.

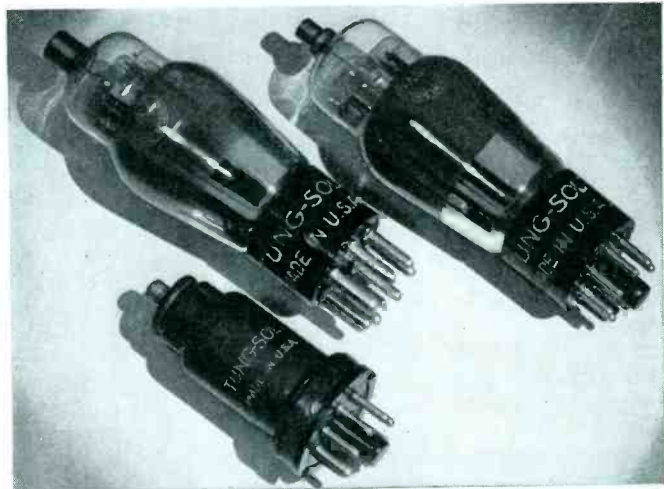

SALES OFFICES:

Atlanta • Boston
Charlotte • Chicago
Dallas • Detroit
Kansas City • Los Angeles • New York

TUNG-SOL

Flow Radio Tubes

TUNG-SOL LAMP WORKS, INC.
Radio Tube Division -
General Office: Newark, N. J.

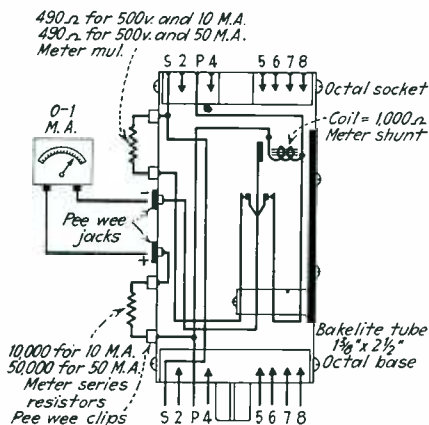

Plate Voltage - Current Adapter

By Allen Beers

The accompanying illustration shows an automatic adapter for reading plate voltage or current of a tube under test. Built around two octal bases the adapter allows a quick checkup on various tubes in a receiver.

The drawing is self-explanatory; to check plate voltage merely insert adapter in tube socket. The reading

obtained will be a no-load figure. To find plate current, plug a tube in the top of the adapter. The plate current energizes the built-in relay coil, causing the meter to read milli-amperes.

The relay is home-made, constructed from a 1000 ohm coil of an old Majestic speaker. The center arm was taken from a discarded vibrator, the side contacts from a two circuit jack.

It should be noticed that the relay coil is used as a meter shunt. Since it is 1000 ohms resistance it is necessary to insert 10,000 ohms in series with the meter. This is mounted on the lower left side of the diagram. The resulting combination increases the meter range to 10 ma. For 50 ma. scale use 50,000 ohms.

The voltage multipliers, mounted above, should be 490 ohms for 500 v. and 10 ma., 450 ohms for 500 v. and 50 ma. Small clips mounted on the side of the adapter permit these values to be changed.

The relay center contact, of light steel, should be adjusted so that it remains in the "voltage" position, releasing and contacting the other side when 2 ma. or more flow through the relay coil.

Simple Condenser Bank

By Wm. C. Clouinger

In constructing a small condenser bank, the use of a two-gang switch instead of the usual four-gang will result in a considerable saving.

It is necessary to use four condensers per switch as shown in the original

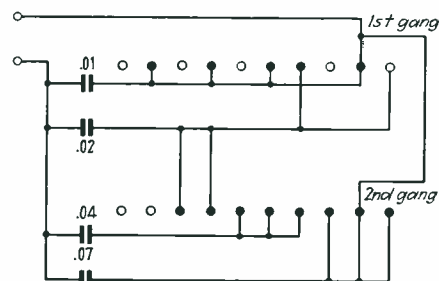

article "Easily Built Signal Generator and Condenser Bank" by Jim Kirk, August 1937. The secret lies in the proper choice of condenser values. The schematic illustrates the principle.

In order to obtain the correct values condensers may be parallel. For example, a .06 mfd. and .01 mfd. unit may be substituted for the .07.

Outstanding Superiority Demonstrated!

New 1938 IMPROVED POWER OUTPUT-EMISSION TUBE TESTER!

(Pat. Sept. 15, 1936)

All P.O.E. Testers now have etched panels and plug-in type copper oxide rectifiers.

Improved 1938 circuit matches impedance values from 4,000 to 2 1/2 Megohms. Covers entire ranges of all receiving set tubes. Same features as tube manufacturers use in production.

Model 1504

Permits complete set testing. Combines Free Point Tester with the following servicing instruments:

1. Power Output Test for All Amplifying Tubes.
2. Emission Test for All Tubes.
3. Free Point Tester.
4. Neon Short Test.
5. Separate Diode Test.
6. D.C. Voltmeter.
7. D.C. Milliammeter.
8. A.C. Voltmeter
9. Ohmmeter.
10. Condenser Test for Shorts.
11. Electrolytic Condenser Leakage Test.
12. Decibel Meter.



EXCLUSIVELY
TRIPLET

MODEL 1504
DEALER'S
PRICE
\$62.33

TRIPLET ELECTRICAL INSTRUMENT CO.
2011 Harmon Ave., Bluffton, Ohio
... Please send me more information on Model 1504; ... Model 1503; ... Model 1502.

Name
Address
City State



Model 1503—Same as 1504 except does not have Free Point Tester. NET DEALER PRICE..... **\$51.33**

Model 1502—Power-Output-Emission Tube Tester only. Same case as Model 1504. Truly a final analysis tube tester. NET DEALER PRICE..... **\$40.33**

FOR THE FIRST TIME!

**A ONE-WATT
Precision
VITREOUS
RESISTOR**



RITEOHM 71

Ohmite vitreous enamel advantages in compact, 1 watt, 1% accurate, precision resistors. Ohmite opens a new field with this achievement—time-proven vitreous enamel now made available to protect the accuracy of small, close-tolerance resistors for meter multipliers, test sets, laboratory equipment and other applications. Bulletin 108 lists the many stock values of the new Riteohm 71.

OHMITE

MANUFACTURING COMPANY
4845 Flourney Street Chicago, U. S. A.



● New CLAROSTAT SERVICE MANUAL is yours for the asking. Over 200 pages. Handy pocket size. Contains most extensive listings of controls and ballast replacements. Also other practical data. Get your copy NOW!

● New manual contains most extensive listings.

● Standard and exact-duplicate types for every job.

● Exact-duplicates insured to fit mechanically and electrically.

● Each unit guaranteed for satisfactory performance.

● Nearest CLAROSTAT jobber stocks these replacements.

● You'll save time, labor, money and comebacks with CLAROSTAT.

CLAROSTAT Manufacturing Co. Inc.

285-287 NORTH SIXTH STREET
BROOKLYN, NEW YORK, U.S.A.

• OFFICES IN PRINCIPAL CITIES •

**WHEN IT COMES TO
TRANSFORMERS**



I don't gamble!

● "In servicing radio sets—I always make it a practice to use Jefferson Transformers—because my customers so often find their sets performing better even than when new. "I make more profits because this cuts 'going-back' expense, and repeat business comes my way."

A Type for Every Purpose

Jefferson Transformers are made for every radio requirement—a line that had its start when radio was first introduced—with Jefferson engineers closely in touch with every development and supplying the finest set builders in the country.

Ask your jobber or write for our complete radio catalog and free amplifier diagrams . . . Use the coupon below . . . JEFFERSON ELECTRIC COMPANY, Bellwood (Suburb of Chicago), Illinois. Canadian Factory, 535 College St., Toronto, Ont.



**JEFFERSON
TRANSFORMERS**

JEFFERSON ELECTRIC CO., Bellwood, Illinois

Please mail—free of charge—new catalog 371-R and Amplifier Manual to:

NAME.....

ADDRESS.....

CITY AND STATE.....

SHORTCUTS

Testing Noisy Tubes

By Roger Hertel

Whenever a tube is suspected of causing noisy intermittent reception use care in testing it. Make sure the filament is cold when it is placed in the tester. Press the test button immediately after placing the tube in tester socket. Hold the button down while the tube warms up. If the meter does not rise evenly but jumps to maximum you can be assured you have an erratic tube.

With this method of testing, erratic tubes usually show up in the tester and much time can be saved. As a further suggestion for simplifying the procedure, the push button switch may be substituted by a toggle switch.

prevent metal filings from entering the voice coil assembly.

Once the filings are attracted to the pole piece it is impossible to thoroughly clean them out without removing the cone. Often they go unnoticed until they short the voice coil. Sometimes they show up as a distinct form of distortion, causing all signals to appear fuzzy.

P. M. dynamic speakers should be very carefully protected when working on a chassis. With this type the full magnetic force is on at all times, greatly increasing the danger.

will permit removal for voltage readings. The 1000 ohm resistor should be 1 per cent accurate, and if used for high current ranges, 10 to 20 watts. If the meter is 2000 ohms per volt substitute a 2000 ohm resistor in place of the 1000 ohms.

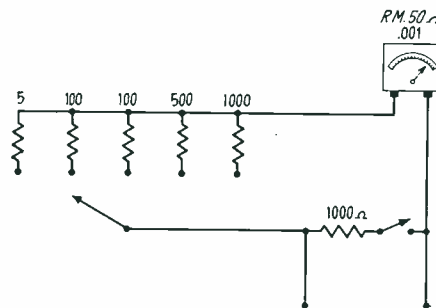

Milliammeter From Voltmeter

By B. Allen

It is a simple matter to convert a multi-range voltmeter to a multi-range milliammeter. With the addition of a 1000 ohm shunt resistor across the test rod terminals the voltage ranges automatically become current ranges.

The 1000 ohm resistor connects from the hot side of the multiplier switch to the negative side of the meter. A s.p.st. switch in series with the shunt

Cleaning Variable Condensers

By Fred P. Steinmetz

Some closely spaced variable condensers are impossible to clean with the usual pipe cleaner. A toothpick wrapped closely with silk thread makes an excellent tool.

Speaker Kink

By George Messig

When replacing transformers, and it is necessary to drill holes in the set chassis, wrap a rag around the speaker cone front and rear. This will

"PINCO" POWER SUPPLY UNITS

DYNAMOTORS GEN-E-MOTORS CONVERTERS

"PINCO" dynamotors, gen-e-motors and rotary converters provide the last word in power supply units for air craft, police, marine and auto radios; also for public address systems. Now widely used by leading air lines and municipal and federal agencies throughout the world. Available in a wide range of capacities for every requirement. Compact, light weight. Sturdily constructed to assure long dependable service. Write for complete information.

PIONEER GEN-E-MOTOR CORPORATION
Manufacturer of "PINCO" Products
Dept. No. R-1K
466 W. Superior Street, Chicago, Illinois

OTHER "PINCO" PRODUCTS

RED TOP and GOLD CROWN gas engine driven electric light and power plants, 100 to 2000 watts; alternating or direct current; air or water cooled; remote control. Send for literature.



This Changer Unit Sells Combinations

USE the popular low-cost General Industries automatic record changer unit to step up radio set buyers to combinations with automatic playing. Does it easily, with its superior high-fidelity reproduction and its surprisingly low additional cost. Develops more and more sales volume on good records, too.

Each unit complete, ready to place in cabinet, combines: (1) Famous Flyer induction type precision-built self-starting motor—silent, self-lubricating, dependable. (2) Latest flat-type, flexible, matched and balanced pickup. (3) Simplified, trouble-free automatic changer mechanism.

Two models, each attractively finished in durable statuary bronze:

Model "L" shown above plays and automatically changes eight 10" or seven 12" records, repeating the last. Model "K" plays and changes eight 10" records and plays 12" records changed by hand. Order samples for test. Please be sure to specify whether AC, DC or universal AC-DC and give exact voltage and frequency of the current used.

The GENERAL INDUSTRIES CO.

3737 Taylor Street, Elyria, Ohio

VOLUME VIII—JUST OFF THE PRESS



The Extra Features make
VOL. VIII RIDER MANUAL
An Even Greater Value . . .

- 1. EXTRA PAGES**—1650 pages of complete servicing data on 1937-38 receivers. Complete because everything is included that more than 100 manufacturers gave us. For COMPLETENESS and COVERAGE get Rider's Volume VIII.
- 2. EXTRA SUPPLEMENT**—"How It Works"—A 64-page special section of Rider's Volume VIII giving explanations of the electrical operations of the more complicated 1938 receivers and instruments . . . Principles and theory you need.
- 3. EXTRA FACTS**—Installation and servicing instructions for many types of inter-communication systems . . . Also servicing data on the electronic musical instruments (has never appeared in any other manual) and New Public Address Amplifiers.

AND A NEW RIDER-BOOK
AUTOMATIC FREQUENCY CONTROL SYSTEMS
by John Rider
With Automatic Frequency Control Circuits in most new higher-priced models, knowledge of "AFC" means money in your pocket! Learn the practical facts, from these easy-to-understand explanations. Get your copy today. Cash in on profitable "AFC" work.
Hard Covers—144 pages—\$1.00
SEND FOR COMPLETE LIST

JOHN F. RIDER, Publisher
1440 BROADWAY
NEW YORK CITY

YOU NEED ALL 8
Rider
MANUALS

JUST OUT!
VOLUME VIII
\$1.00

What's Radio Retailing Say?

If you read it in RADIO RETAILING it is true—and timely.



That goes for both the editorial and the advertising contents of this, the radio industry's recognized leading publication!

RADIO RETAILING

330 W. 42d St., New York, N. Y.

TRANSOIL
for transmitting
NEW HIGHEST QUALITY OIL CAPACITORS
S O L A R MFG. CORP. **SOLAR** 599 BROADWAY NEW YORK CITY

6 REASONS WHY SUPREME



Model 546 3" Cathode Ray Oscilloscope. \$6.50 down—\$5.95 for 10 months. \$59.95 Cash Price.

VISUAL SERVICING WILL INCREASE YOUR PROFITS!

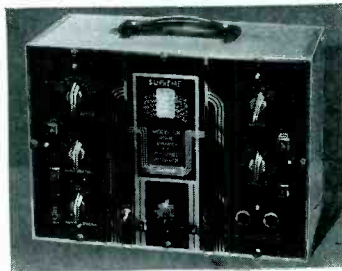

Model 581 Signal Generator \$6.00 Down—\$5.44 for 10 months on S. I. C. terms. \$54.95 Cash Price

ALL visual servicing is not alike! That's why you should demand *proof* of its accuracy and profit-making ability—before you buy!

Shown here are six profitable short-cuts that allow you to do service work *more quickly, more efficiently!* A few of the many dozens of uses to which you can place SUPREME Model 581 Signal Generator and SUPREME Model 546

3" Cathode Ray Oscilloscope—the perfect instrument combination for Visual Servicing *because they were both designed to work together!*

The SUPREME 581 Signal Generator and Frequency Modulator gives you: Razor-Edge *Shadow Tuning*—Giant 340 degree dial—38 to 1 knob to condenser ratio—actual 8 feet long scale length—125 KC to 60 MC on 8 bands—can be used as (1) Unmodulated R. F. oscillator (2) 400 cycle—30% amplitude modulated RF oscillator (3) 24 KC fixed band width frequency modulated RF oscillator (for visual alignment) (4) Externally amplitude modulated RF oscillator (5) Fixed 400 cycle AF oscillator (6) Variable 60 to 10,000 cycle AF oscillator (7) Power supply frequency time base for scope.

Model 546 3" Cathode Ray Oscilloscope gives you:—(1) Lowest price complete 3" tube scope (2) 0 to 90,000 cycle linear vertical and horizontal gain controlled amplifiers (3) 15 to 30,000 cycle saw toothed linear time base (4) "Snap Lock" Synchronization circuit (5) Internal or external synchronization circuit (6) All controls including "Spot Centers" on panel (7) D. C. or A. C. signal can be fed direct to deflecting plates.

For the utmost in high precision, low cost, latest design and complete satisfaction, see SUPREME before you buy!

HERE ARE THE 6 REASONS!

- 1. Visual Alignment**— R. F. and I. F. circuits on modern, high fidelity receivers properly aligned.
- 2. Audio Response**— Over-all audio response and "stage-by-stage" analysis measurements made in receivers and P. A. or theater amplifiers.
- 3. Hum Check**— Objectionable hum quickly traced and eliminated.
- 4. A. F. Amplifier Overload**— Audio frequency distortion caused by overload or phase shift located and corrected.
- 5. I. F. Amplifier Overload**— I. F. Overload with resulting A. F. signal distortion found and removed.
- 6. Demodulator Distortion**— Demodulator Output Waveforms checked and distortion or possible presence of R. F. located.

Combination Offer! Model 546 3" Oscilloscope *Plus* Model 581 Signal Generator, Only \$11.50 down—\$9.48 per month for 12 months on SUPREME S. I. C. terms.

SUPREME INSTRUMENTS CORP., Greenwood, Miss.
Export Dept., Associated Exporters Co., 145 W. 45th St., New York City
Cable Address: LOPREH, New York

AMPERITE *presents* THE ACOUSTIC COMPENSATOR

3 IMPORTANT USES



PUSH UP TO
INCREASE
HIGHS
PUSH DOWN
TO INCREASE
LOWS



(1) The Acoustic Compensator enables you to lower or raise the response of the microphone by the mere flip of the finger! (2) Makes the Velocity immediately adjustable to close talking or distant pickup. (3) Immediately adjustable to any type of job or occasion.

MODELS RBHk, RBMk, with acoustic compensator. Frequency range 40 to 11,000 CPS. Output, -65 db. Switch, cable connector, 25' of cable. \$42.00 LIST

MODELS RBHn, RBMn, without acoustic compensator. \$42.00 LIST

AMPERITE CONTACT MICROPHONE



Ideal for use on all string instruments. No distortion. No string changes. Unusual high output. -40 db. Can be used on radio sets. Operates with high or low gain amplifiers. Frequency response 40 to 9000 cps.

MODEL KTH (hi-imp); KTL (200 ohms); 25' of cable. \$22.00 LIST
KTH or KTL with foot-operated volume control. \$30.00 LIST

AMPERITE "HAND-I-MIKE"

Smallest velocity made but has an output equal to larger types. -68 db. Frequency range 60 to 7500 cps. Excellent for close talking. Can be used as hand desk or stand mike. Very rugged. MODELS HDH (hi-imp); HDL (200 ohms); with switch. \$22.00 LIST



MODEL RAL \$22.00 LIST



A popular Amperite Velocity. Excellent for speech and music. No peaks. Flat response. Output, -68 db. Triple shielded. Shock absorber, swivel bracket. MODEL RAL (200 ohms); or MODEL RAH (hi-imp). \$22.00 LIST

FREE: Window Decal and Window Display.
NEW! Special Sound Equipment Letterheads.
Write for these sales helps, and new bulletins, now!

AMPERITE Co. 561 BROADWAY, N. Y.
Cable Address: Alkem, New York

AMPERITE
Velocity
MICROPHONE

TRICKS

GE F135

Automatic tuning inoperative, manual tuning normal . . . tap relay on left front side, looking at chassis from rear. If still inoperative, clean and adjust relay contacts.

GENERAL ELECTRIC K52

Volume decreases a short time after set is turned on. Especially troublesome when new set of tubes are installed. . . . Replace 27 AVC tube (center rear of chassis) with 56.

GRUNOW 542

Inoperative on short waves, broadcast normal . . . touch control grid of 6Q7 with switch in short wave position. If no signal, replace .02 mfd. bypass from one leg of switch to ground with 600 volt type.

GRUNOW 1191

Tuning indicator tube short lived . . . open plate circuit of this tube and insert 50,000 ohm 1/2 watt resistor. This keeps plate voltage at safe value.

GRUNOW 1291

Intermittent oscillation and motor-boating . . . open screen bypass on 6J7. Replace with .1 mfd. 400 volt unit.

GRUNOW 1541

Dead, except for strong locals . . . look for open acoustic filter choke in plate circuit of 6R7.

MOTOROLA GOLDEN VOICE 1936

Muffled tone, distortion at low level . . . open volume controls, replace with 500,000 ohm potentiometer.

PHILCO 30

Low volume . . . look for high resistance in i.f. coils. Replace defective coils with new units.

PHILCO 37-33, 37-38

Remove 1500 ohm resistor across "C" battery in 37-33 model and 900 ohm resistor in the 37-38. Replace with 6000 ohm value. Low value shortens battery life.

RCA 60

Fading, distortion . . . open secondary of audio coupling transformer.

EXACT-DUPLICATE Replacements



from
A to Z

- Precisely so, for AEROVOX has listed a matched condenser replacement for every popular set from A (Atwater-Kent) to Z (Zenith) and everything between.
- Each AEROVOX Exact-Duplicate Replacement Condenser precisely matches the initial set equipment—physically, electrically, visually.
- Such a servicing job fits right, works right, looks right. The customer is bound to be satisfied.
- And an AEROVOX Exact-Duplicate Replacement usually costs less than a corresponding batch of standard units taped together.

Ask . . .

your jobber — or write us direct — for copy of latest catalog with listing of exact-duplicates.



AEROVOX
CORPORATION
70 Washington St. Brooklyn, N. Y.
IN CANADA: AEROVOX CANADA, Limited, Hamilton, Ont.

MASTER of all it surveys—

AN ALL-SERVICE TUBE AND SET TESTER

- for general radio servicing
- for auto radio servicing
- for public address systems, sound equipment and transmitters

THIS great addition to the impressive list of sensational Simpson developments has been named the "Test Master" because it offers complete mastery of every condition that can arise in every branch of radio servicing—in the store or on the job—now, or in years to come.

No other instrument, selling at any price, covers so much ground—yet its price is lower than that of instruments that do not approach its range, its accuracy, its stamina, its beauty of design and finish. Here, briefly, are some of the features it brings to you:

A tube tester of improved design—based on R. M. A. standards, employing double switching of filament terminals (which eliminates obsolescence) for testing special types such as 5X4G, 5Y4G, 6A5G, 6P7, etc., without adaptors or special sockets. It provides screen fluorescence and angle test for "magic eye" tubes; hot cathode

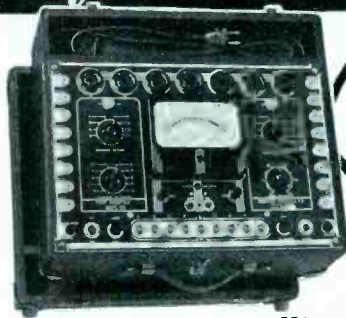

the **NEW Simpson**
"TEST MASTER"

MODEL 440

No other tester, selling at any price, provides as many tests and ranges!

Yet the dealer's net price is only \$59.00

leakage neon test and "high sensitivity" neon short check—individual tests for each electrode in tube. Cathodes, diodes, battery types and gaseous rectifiers are tested under proper load. Even "noise test" pinjacks are provided for ear phone connection. Impressive "good" and "bad" scale is provided as well as percentage scale for comparing or matching tubes. It is a tube tester that tells the whole story to you and your customer in your terms and his terms. Tube charts in loose leaf form are readily accessible in the cover. Supplementary cards are easily added

A set tester of tremendous scope—As a set tester the Model 440 has six A.C. and D.C. voltage ranges at 1,000 ohms per volt—0-7.5-30-150-300-750-1500. All A.C. ranges are available for output measurements. Three ranges cover resistance from 1 ohm to 100,000,000 ohms. Scales are 1,000 ohms (30 ohms center); 100,000 ohms (1,000 ohms center); 100,000,000 ohms (1,000,000 ohms center). Four milliamperage ranges are provided—0-3-15-75-300. There are six decibel ranges of -12 to +58. D.C. current range of 0-15 amperes is incorporated for auto work. Capacity range is 0-30 microfarads. Meter leakage test for all condensers including electrolytics is provided.

There is truly nothing that you can ask for, or find in any instrument that is not covered by the Model 440 at the moderate price of \$59.00. It is sold on deferred payments. Write today for complete description.

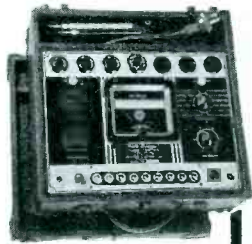

Model 220 "Roto-Ranger" Tube and Set Tester—a great tester with the convenient Simpson Roto-Ranger feature which provides separate resistance scales of 100-100,000-100,000,000 ohms—separate D.C. scales of 8-300-1,000 volts. **\$62.75**
Net price
(Sold on Terms)

SIMPSON ELECTRIC CO., 5216 KINZIE STREET, CHICAGO, ILLINOIS

SIMPSON Instruments that *STAY accurate*
ASK YOUR JOBBER

Model 201 and 202 "Roto-Ranger" Volt-Ohm-Milliammeter with twelve independent scales covering all ranges for general servicing. Net price Model 201 (for D.C. only) **\$32.50**
Price Model 202 (A.C.-D.C. type) **\$35.75**
(Sold on Terms)



- Build Profits
- Satisfy Customers
- Flexibility to meet EVERY requirement

REMLER

INTER-COMMUNICATION SYSTEMS

Build a permanent and worthwhile business with profitable Remler systems. Priced to meet competition with new features which are not available in other systems, regardless of price!

Modern styling . . . bakelite cabinets . . . superior station selector system . . . high intelligibility . . . approved by Underwriter's Laboratories. Prices start at \$49.50 for two station systems.

REMLER—SINCE 1918

Remler Inter-Communication Systems are backed by the reputation and stability of a trustworthy firm continuously under the same management for twenty years. Write for catalogue sheets, price lists, illustrated folders, sales helps and name of nearest distributor.

REMLER COMPANY, Ltd., 19th at Bryant, San Francisco

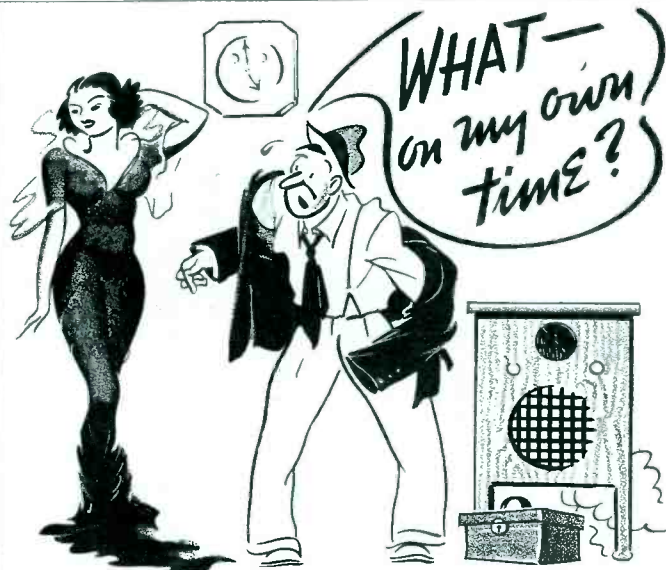

No service man likes to make good a job failure in or after working hours. That is why so many radio repair men are using Ward Leonard Replacement Parts. These parts are conservatively rated and thoroughly tested before you get them. Send for data shown in Price List No. 507A.

WARD LEONARD ELECTRIC COMPANY

35 SOUTH STREET, MOUNT VERNON, N. Y.

Please send me service man's price sheets No. 507A.

Name

Address

City State

Jobber's Name

RADIO'S *Fairest* DEAL RADIO'S *Finest* TUBE!

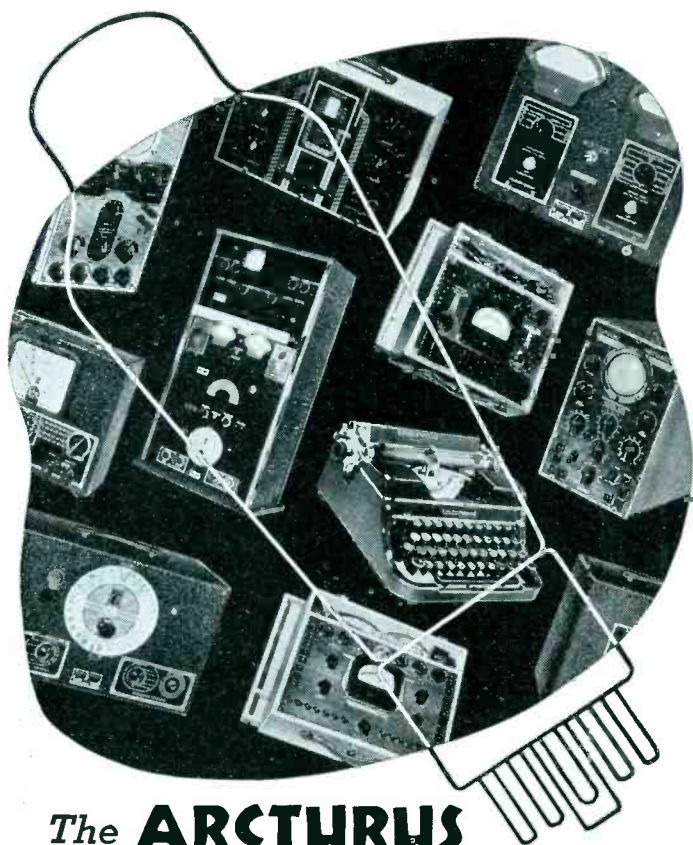

The **ARCTURUS** EQUIPMENT DEAL *Is Making Radio History!*

Year after year ARCTURUS has led the way in tube engineering design and research . . .

Now ARCTURUS again pioneers by offering the fairest, easiest equipment deal in the history of radio.

The ARCTURUS offer includes a wide variety of highest quality standard equipment—tube and set testers, oscilloscopes, portable typewriters, etc. It gives you **IMMEDIATE DELIVERY** with only a small down payment . . . tube requirements are surprisingly low . . . ARCTURUS quality and ARCTURUS Dealer Helps actually *help* you sell. You profit two ways!

AND REMEMBER: You buy tubes at **STANDARD LIST PRICES**, less *standard* discounts. We haven't added one cent extra! Nothing could be fairer! You simply cannot lose . . . Write for details.

Modern Service Demands Modern Equipment . . .

Let ARCTURUS help make yours the best equipped shop in town!



ARCTURUS RADIO TUBE CO., Newark, N. J.

ARCTURUS

**INDEPENDENT TUBES FOR DEALERS WHO
DO THEIR OWN INDEPENDENT THINKING**



is the **ONE** thing
to remember . . .



FOR A PROFITABLE BUSINESS IN VIBRATORS

Here's the vibrator that has **EARNED** customer preference by its ability to "TAKE IT". **UTAH** vibrators are **TOUGH**. Impartial tests **PROVE** it. That's why manufacturers have chosen it for original equipment in more than a million sets. That's why it is the preferred vibrator for replacement service. It's the easiest vibrator for you to sell—and the most profitable, too. Exclusive **UTAH** design and construction mean no costly "comebacks" for you. **UTAH** vibrators work better, last longer but cost no more. Just a few models service any radio. When ordering vibrators, remember the name **UTAH**. It's the profitable thing to do.

*Original Equipment in More Than a
Million Sets.*

UTAH RADIO PRODUCTS CO.
CHICAGO, U. S. A.

TORONTO ONTARIO, CANADA BUENOS AIRES (UCOA RADIO PRODUCTS CO.)

'16 YEARS OF LEADERSHIP'



Look for the Name **MUELLER** WHEN YOU BUY YOUR CLIPS



Made to Last Longer

THE ONLY COMPLETE LINE

8 Different Sizes—Copper—Steel—Insulated and Uninsulated
Send for **FREE SAMPLES** and Catalog 780

Mueller Electric Co.

Clip Makers for 29 Years
1583 E. 31st St., Cleveland, Ohio

Universal Crystal Microphones



\$22.50
List

Ideal for special events, broadcasts, call systems, amateur 'phones, p. a. systems, etc.

Rugged. Chrome finish. Furnished in handi-mike or stand model (as shown). Includes 10 ft. cable.

Desk stands extra. \$2.50 for handi-model and \$3.50 for stand model. Licensed under patents of Brush Development Co.

MICROPHONE DIVISION

UNIVERSAL MICROPHONE CO. LTD.
424 Warren Lane Inglewood, Calif., U. S. A.

TRICKS

RCA-VICTOR R-21

Low hum, strong motorboating when the 47 behind the 80 rectifier is removed . . . one megohm resistor from terminal 3 on phono terminal strip shorting to terminal 4. To test, short terminal 3 and 4 with screw-driver. If hum does not increase the trouble is at this point.

REMLER 62

Cuts off with whistle on resonance with strong signal. . . . Check for badly leaking .1 mfd. 6F6 bias bypass.

SILVERTONE 1850

Intermittent, weak . . . check 4½ volt "C" battery. If the voltage is not up to full value operation will be erratic.

Champions HAVE SOMETHING EXTRA



A FORWARD pass right down the middle — the receiver gathers it in — he's away — and over for a touchdown!

It's that "something extra" that makes the pass click — CHAMPION Radio Tubes have that "something extra"—both in Quality and dependable service — and pass to the jobber and dealer those extra PROFITS.

For information write
CHAMPION RADIO WORKS
Danvers, Mass.

Champion radio tubes

★Division Consolidated Electric Lamp Co.
★Makers of Champion Lamp Bulbs



The World's Fastest Selling Line of DRY ELECTROLYTIC CAPACITORS

WHEN you order C-D electrolytics you KNOW that, whether it be an "8 mike" or a "16 mike," it will be absolutely the best obtainable in the industry.

If you could step behind the scenes at the Cornell-Dubilier plant and witness the careful selection and inspection of raw materials, the extreme precautions taken by C-D engineers to insure positive sealing, (C-D dry electrolytics are triply sealed), against corrosion and humidity, and the endless test and inspection of the finished electrolytic, you would understand why these condensers are the world's fastest selling line of electrolytics.

Be sure you say "C-D" when ordering your dry electrolytics. Send for complete technical data, Today!

**CORNELL-DUBILIER
ELECTRIC CORPORATION**
1000 Hamilton Blvd., So. Plainfield, N. J.

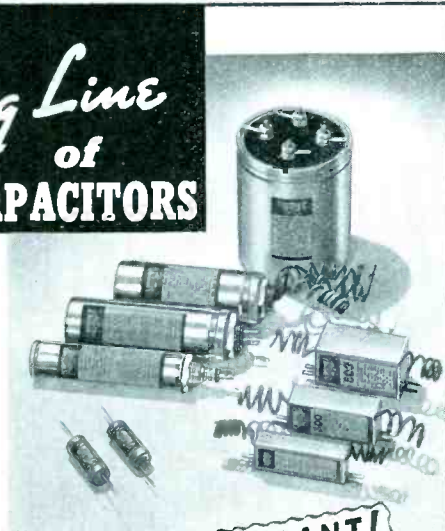

MOST IMPORTANT!
C-D ELECTROLYTICS
are UNCONDITIONALLY
GUARANTEED AGAINST
INTERNAL CORROSION
The most STARTLING, SWEEPING,
condenser GUARANTEE EVER
WRITTEN, and a dramatic example
of C.D. engineering ability.



**CORNELL-DUBILIER
ELECTRIC CORPORATION**
South Plainfield, New Jersey

Get Smart!
USE THESE NEW
SERVICE SHORT CUTS
SPEED UP YOUR SERVICE WORK
with these amazing new "TWIN
GADGETS" to show you just exactly
what test to make and what remedy to
use for OVER 400 Common Receiver
Troubles. Each gadget is a pocket-
sized pack of circuit cards, alphabetized
together and arranged for instant refer-
ence for any trouble symptom.

**Ghirardi's
TWIN "TROUBLE SHOOTERS"**
worth weeks of pay!

They'll earn their keep over and
over again. Save you hours of fidd-
ling and tuning. Just the flip of a
card and there's your answer in-
stantly—plus as the nose on your
face. Easiest and handiest little service
gadgets you ever saw. Full directions on
each. Nothing like them ever before—
both "brand-new!" One for HOME
RADIO sets one for AUTO-RADIO
sets—you need 'em both—to keep in
your pocket and use on every service
call. Only \$1.00 each. Foreign—
GUARANTEED at that! So here's
what to do this very minute to get
your Gadgets—Clip a dollar to this
ad, write your name and address on it
and mail to:

RADIO & TECHNICAL PUB. CO.,
Dept. RR-117, 45 Astor Place, New York
Money Back Guarantee

MAIL NOW!
**\$1 FOR THE
PAIR**

417 THINGS
Every Service Man Must Know!

Test Instruments—Circuit Diagrams
—Trouble-Shooting—Up-to-date Re-
pair Methods—"Case Histories" of
over 1,500 Receivers—6,000 I.F.'s—
Auto-Radio servicing Data—etc. GHIR-
ARDI gives you ALL this INVALU-
ABLE DOPE and MUCH MORE in these

1,832 PAGES 2 great servicing books—one for test and
813 ILLUS. repair methods—the other for quick-use
job and receiver data. Regular Supple-
ment Sheet Service for Data Book. Send
for Free Circular.

RADIO & TECHNICAL PUBLISHING CO.
Dept. RR-117, 45 Astor Place, New York

**\$6 for
BOTH BOOKS MODERN RADIO SERVICING
RADIO FIELD SERVICE DATA**

Just String Up

TACO ANTENNA SYSTEMS
and make many Extra Dollars

- Equip any set, anywhere, any owner, with a TACO Antenna System. Presto! Ideal results. Broadcast and short-wave. Minimal background noise.
- All because TACO (Licensed under A.A.K. Inc. Patents) represents most advanced engineering by specialists.
- Factory assembled, wired, soldered. New low-loss transformers. A model for every pocketbook.
- Also a Master Antenna System for private dwellings, providing any number of radio set outlets. Same job used for apartment houses, hotels, hospitals, etc.

New DATA: Ask your local TACO jobber or write us direct for technical details and merchandising ideas.

TACO

TECHNICAL APPLIANCE CORP.
17 East 16th St. New York City
IN CANADA: 414 Bay St., TORONTO

INDEX TO ADVERTISERS

November, 1937

	Page		Page		Page
AEROVOX CORP. (Condensers)	94	KELVINATOR DIV., NASH KELVINATOR (Refrigerators)	34, 35	STANDARD TRANSFORMER CO. (Transformers)	75
AMERICAN COMMUNICATIONS CORP. (Code Reader)	67	KEN-RAD CORP. (Tubes)	57	STEWART-WARNER (Radio Sets)	27
AMPERITE CORP. (Microphones)	94	LEONARD DIV., NASH-KELVINATOR	44, 45	STROMBERG CARLSON TELE. MFG. CO. (Radio Sets)	2
ARCTURUS RADIO TUBE CO. (Tubes)	96	MAJESTIC RADIO & TELEVISION CORP. (Radio Sets)	68	SUPREME INSTRUMENT CORP. (Test Equipment)	93
BELMONT RADIO CORP. (Radio Sets)	7	MALLORY & CO., INC., P. R. Inside Front Cover (Replacement Parts & Power Packs)		TECHNICAL APPLIANCE CORP. (Antenna Systems)	97
BRACH MFG. CO., L. S. (Antenna Systems)	68	McMURDO-SILVER CO. (Radio Sets)	60	TRAV-LER RADIO CORP. (Radio Sets)	71
BRIGGS & STRATTON CORP. (Gas Engines & Generators)	12	MUELLER ELECTRIC CO. (Wire Clips)	96	TRIAD MANUFACTURING CO. (Tubes)	67
CHAMPION RADIO TUBE CO. (Radio Tubes)	97	NATIONAL CARBON CO. (Dry Batteries)	8, 46	TRIPLETT ELECTRICAL INSTRUMENT CO. (Test Equipment)	90
CLAROSTAT MFG. CO. (Volume Controls)	91	NATIONAL UNION RADIO CORP. (Radio Tubes)	84	TUNGSOL RADIO TUBES, INC. (Tubes)	87
COMMERCIAL CREDIT COMPANY (Finance)	10	NORGE DIVISION, BORG-WARNER CORP. (Refrigerators)	38, 39	UNIVERSAL MICROPHONE CO. (Microphones)	96
CORNELL-DUBILIER CORP. (Condensers)	97	OHMITE MFG. CO. (Resistors)	91	UTAH RADIO PRODUCTS CO. (Vibrators)	96
CORNISH WIRE CO. (Antennas)	60	PIERCE-AIRO, INC. (Radio Sets)	60	WARD LEONARD MFG. CO. (Replacement Parts)	95
CROSLY RADIO CORP. (Radio Sets)	Inside Back Cover	PIONEER GENE-MOTOR CORP. (Electric Plants)	92	WESTON ELEC. INSTRUMENT CO. (Test Equipment)	77
CROWE NAMEPLATE & MFG. CO. (Remote Controls & Escutcheons)	72	RADIO CORP. OF AMERICA (Sound Engineering)	4, 5	WHOLESALE'S SALESMAN (Publication)	58
ELECTRIC STORAGE BATTERY CO. (Storage Batteries)	67	RADIO RETAILING (Trade-In Allowance Blue Book)	64	WILCOX-GAY CORPORATION (Radio Sets)	75
FAIRBANKS, MORSE & CO. (Refrigerators)	30, 31	RADIO & TECHNICAL PUBL. CO. (Service Manuals)	97	WINCHARGER CORP. (Wind Electric Chargers)	56
GENERAL ELECTRIC CO. (Radio Sets)	Back Cover	RAYTHEON PRODUCTION CORP. (Tubes)	9		
GENERAL INDUSTRIES CO. (Phono. Motors, Record Changers)	92	RCA MANUFACTURING CO., SET DIVISION (Radio Sets)	51, 52, 53, 54	SEARCHLIGHT SECTION	
GLOBE-UNION, INC. (Storage Batteries)	87	READRITE METER WORKS (Test Equipment)	82	<i>Classified Advertising</i>	
HORTON MFG. CO. (Electric Washers)	68	REMLER CO., LTD. (Inter-Communicating Systems)	95	Classification	Page
HYGRADE-SYLVANIA CORP. (Tubes)	6	RIDER, JOHN F. (Service Manuals)	93	BOOKKEEPING SERVICE	
INDIAN PRODUCTS CORP., KOOL-ROOM DIVISION (Room Cooler)	3	RIVARD WIRE & CABLE CORP. (Antenna System)	60	Appliance Bookkeeping Service	99
INTERNATIONAL RADIO CORP. (Radio Sets)	19	SERVEL, INC. (Refrigerators)	40	CATALOGS	99
INTERNATIONAL RESISTANCE CO. (Resistors)	78	SIMPSON ELECTRIC CO. (Service Instruments)	95	EMPLOYMENT	99
JANETTE MANUFACTURING CO. (Rotary Converters)	68	SOLAR MANUFACTURING CO. (Condensers)	93	SERVICEMEN'S SPECIALTY	
JEFFERSON ELECTRIC CO. (Transformers)	91			Akrad Products Co.	99
JENSEN RADIO MFG. CO. (Speakers)	72			RADIO STOCKS	

Although Radio Retailing takes every precaution to insure accuracy, we cannot assume responsibility for an occasional change or omission in the above index.

McGraw-Hill Publishing Company, Inc. Publication Office: 99-129 North Broadway, Albany, N. Y. Editorial and Executive Offices: 330 West 42d Street, New York, N. Y. Branch Offices: 520 North Michigan Avenue, Chicago; 883 Mission Street, San Francisco; Aldwych House, Aldwych, London, W. C. 2; Washington; Philadelphia; Cleveland; Detroit; St. Louis; Boston; Atlanta, Ga.

FACTORY CLOSEOUT OF RADIO TUBES

TYPES			
1A6	6B7	35	57
1C6	6C6	41	59
2A3	6D6	42	75
2A6	6F7	43	77
2A7	10	46	78
2B7	12Z3	19	82
5Z3	24	49	85
6A6	32	55	89V
6A7	34	56	99X

R. C. A. licensed new unbranded, fully tested and guaranteed. Quantities Limited—Order Now

Orders under 50 tubes, you pay postage. Orders 50 tubes and over, we pay postage.
Order in quantities of 50 tubes and get 5 tubes (our selection)—FREE.

A total net worth in excess of \$10,000.00 assures the responsibility and reliability of this offer.
Orders \$10 and over, 20% with order balance C. O. D.
Special discounts allowed to quantity purchasers

No order less than (\$1.00) one dollar will be accepted

While they last 20c each S. R. Co. 66 Lexington Ave., Passaic, N. J.

• Note—Service Men and Dealers—Satisfied customers from this advertisement are reordering rapidly. These Tubes are going very fast. Get your order in before they are gone.

IF IT'S TOUGH - DON'T CUSS Turn To RADIO-KINK-AIDS

Practical Repairs For Over 3000 Hard-To-Fix Radios.

Just pull out the card corresponding to the name and model of the set you are repairing, and there you have listed the service troubles found in that radio and how to fix them. Yes it's as simple as that.



ONLY \$1.95
COMPLETE WITH METAL CABINET

FREE WRITE FOR BULLETIN R-11 AND SAMPLE CARD

AKRAD PRODUCTS CO.
352 WOOSTER AVE Akron, O.

Tear out this ad, write your Name and Address in the margin, send \$1.95 and we will send outfit at once.

LEGAL NOTICE

STATEMENT OF THE OWNERSHIP, MANAGEMENT, CIRCULATION, ETC., REQUIRED BY THE ACTS OF CONGRESS OF AUGUST 24, 1912, AND MARCH 3, 1933

Of Radio Retailing, published monthly at Albany, N. Y., for October 1, 1937.
State of New York } ss.
County of New York }

Before me, a Notary Public in and for the State and county aforesaid, personally appeared D. C. McGraw, who, having been duly sworn according to law, deposes and says that he is the Secretary of the McGraw-Hill Publishing Company, Inc., publishers of Radio Retailing, and that the following is, to the best of his knowledge and belief, a true statement of the ownership, management (and if a daily paper, the circulation), etc., of the aforesaid publication for the date shown in the above caption, required by the Act of Aug. 24, 1912, as amended by the Act of March 3, 1933, embodied in section 537, Postal Laws and Regulations, printed on the reverse of this form, to wit:

1. That the names and addresses of the publisher, editor, managing editor, and business managers are: Publisher, McGraw-Hill Publishing Company, Inc., 330 West 42nd St., N. Y. C.; Editor, O. Fred Rost, 330 West 42nd St., N. Y. C.; Managing Editor, W. MacDonald, 330 West 42nd St., N. Y. C.; Business Manager, H. W. Mater, 330 West 42nd St., N. Y. C.

2. That the owner is: (If owned by a corporation, its name and address must be stated and also immediately thereunder the names and addresses of stockholders owning or holding one per cent or more of total amount of stock. If not owned by a corporation, the names and

LEGAL NOTICE

addresses of the individual owners must be given. If owned by a firm, company, or other unincorporated concern, its name and address, as well as those of each individual member, must be given.) McGraw-Hill Publishing Company, Inc., 330 West 42nd St., N. Y. C. Stockholders of which are: James H. McGraw, Jr., 330 West 42nd St., N. Y. C.; James H. McGraw, James H. McGraw, Jr., and Curtis W. McGraw, 330 West 42nd St., N. Y. C.; Trustees for: Harold W. McGraw, James H. McGraw, Jr., Donald C. McGraw, Curtis W. McGraw, Curtis W. McGraw, 330 West 42nd St., N. Y. C.; Anne Husus 330 West 42nd St., N. Y. C.; Mildred W. McGraw, Madison, N. J.; Grace W. Mehren, 33 West Grand Ave., Chicago, Ill.; Malcolm Muir and Guaranty Trust Co. of New York, Trustees for Lida Kell Muir, 524 Fifth Avenue, N. Y. C.; F. S. Weatherly, 271 Clinton Road, Brookline, Mass.; Elsa M. Wilsey, Madison, N. J.

3. That the known bondholders, mortgages, and other security holders owning or holding 1 per cent or more of total amount of bonds, mortgages, or other securities are: (If there are none, so state.) None.

4. That the two paragraphs next above, giving the names of the owners, stockholders, and security holders, if any, contain not only the list of stockholders and security holders as they appear upon the books of the company but also, in cases where the stockholder or security holder appears upon the books of the company as trustee or in any other fiduciary relation, the name of the person or corporation for whom such trustee is acting, is given; also that the said two paragraphs contain statements embracing affiant's full knowledge and belief as to the circumstances and conditions under which stockholders and security holders who do not appear upon the books of the company as trustees, hold stock and securities in a capacity other than that of a bona fide owner; and this affiant has no reason to believe that any other person, association, or corporation has any interest direct or indirect in the said stock, bonds or other securities than as so stated by him.

D. C. McGRAW, Secretary.

McGraw-Hill Publishing Company, Inc.

Sworn to and subscribed before me this 27th day of September, 1937.

[SEAL] H. E. BEIRNE,
Notary Public, Nassau County, Clk's No. 74. N. Y.
Clk's No. 192, Reg. No. 8-B-115.
(My commission expires March 30, 1938)

New "SEARCHLIGHT" Advertisements

must be received by Dec. 2 to appear in the December issue.

Address copy to the
Department Advertising Staff
Radio Retailing.

330 West 42d St., New York City

BOOKKEEPING SYSTEM

Designed especially for the small radio sales and repair store.

Larger systems for the general appliance dealer.

Don't guess at—profits, social security tax and loads of detail which this system will give you. Sales, repairs, customer's payments and expenses all entered on daily cash balancing sheet. Totals are transferred to properly designed records. Simple but complete.

Start the New Year Right!

Write today for particulars—stating your class of business

Reasonably priced. Complete instructions
APPLIANCE BOOKKEEPING SERVICE

111 W. Jackson Blvd. CHICAGO, ILL.

OVER 10,000 PARTS FOR VACUUM CLEANERS AND WASHING MACHINES

24-HOUR SERVICE!

Attach this "Ad" to Your Inquiry and Receive Complete Catalog

Manufacturers Factory Representatives
MIDWEST APPLIANCE PARTS CO.
2722 W. Division St. CHICAGO, ILL.

RADIO IN IT'S ENTIRETY!

"B A" serves the trade with every need in radio—complete 160-page catalog of nationally known radio receivers, public address, parts, supplies and equipment. Orders shipped same day received.

COMPLETE CATALOG AVAILABLE

BURSTEIN-APPLEBEE CO. 1012-14 MCGEE ST. KANSAS CITY, MO.

\$500,000 GENUINE

MAJESTIC-GRIGSBY GRUNOW

REFRIGERATOR &

RADIO PARTS.

FOR MODELS

PRIOR TO

1936

G & G GENUINE MAJESTIC REFRIGERATOR & RADIO PARTS SERVICE

5801 W. DICKENS AVE. CHICAGO, ILL.

"SEARCHLIGHT" ADVERTISING RATES

UNDISPLAYED RATE:

15 cents a word, minimum charge \$3.00.

Positions Wanted (full or part-time salaried employment only). 1/2 the above rates, payable in advance.

Proposals, 50 cents a line an insertion.

DISPLAYED—RATE PER INCH:

1 inch \$8.00
2 to 3 inches 7.50 an inch
1 to 7 inches 7.00 an inch

Rates for large spaces, or yearly rates, on request.

An advertising inch is measured vertically on one column, 3 columns—30 inches—to a page.

STOP SEARCHING!

HERE IS YOUR "GUIDE"

LOWEST PRICES

SEND FOR YOUR COPY NOW!

The new 1938 Radolek Radio Profit Guide contains complete showings of Radio Repair Parts, Radio Receivers, Public Address Amplifiers, Speakers, Microphones, Service Test Instruments, Radio Technical Books, Special Radio Tools. Leading Standard Brands! Everything you will ever need in the Radio Business all at Lowest Prices. You save money at Radolek!

GUARANTEED QUALITY

Every item you get from Radolek is guaranteed. It must be right or we make it right. Standard merchandise produced by leading Manufacturers with Radolek's guarantee added!

FASTEST SERVICE

Everything in Radio promptly when you want it—and exactly what you want. Radolek's efficient organization backed by a huge stock of standard guaranteed quality merchandise insures you the fastest service in the Radio business. Twenty-five Thousand Servicemen customers depend on Radolek service and benefit by Radolek's LOWEST PRICES. Send Now for your copy of the Radolek Radio Profit Guide. It will help you make money.

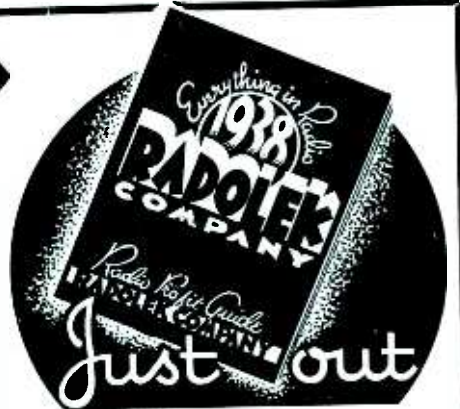

RADOLEK

601 W. Randolph St., Dept. A-13, CHICAGO

Name

Address

Serviceman? Dealer? Experimenter?

Rely on Radolek for "Everything in Radio"

LETTERS

West Answers East

In answer to Mr. Jacoby's letter ("Hollywood Headache") in the September issue I would like to say that the same type of interference has been experienced by Western listeners from the beginning of chain broadcasting from the East.

Thunderstorms cause the crashes he speaks of and he can check with his local telephone company. Not all lines carrying programs east or west are high fidelity. It is clear that the broadcasters are not at fault and the telephone companies are only partially responsible.

I'm afraid Mr. Jacoby expects the impossible.

GLENDALE, CALIF. ROBERT W. K. SMITH
Warner Brothers Pictures, Inc.

W. A. Jacoby's letter anent "Hollywood Headache" touches so close to home that I cannot refrain from commenting.

The difficulty lies primarily with telephone lines. We have been telling the listeners in this area about the blessing of high-fidelity for years but have been able to demonstrate it only on a few local programs.

Telephone lines from here to San Francisco are capable of a maximum response of 5,000 cycles. Network programs to and from Hollywood are transmitted over these lines and until some improvement is made the East will continue to have the same low-fidelity programs from the West that the West has always had from the East.

Developments in Hollywood broadcasting have been so quick that adequate technical equipment has not been made available. Both chains are undergoing construction programs at present. Meanwhile "name" shows are originating in vacant theatres, out-of-date movie studios, etc. With many of the favorite network shows being transmitted by such equipment it is readily understood why "Hollywood Headache" occurs.

I believe present construction will relieve the problem of poor remote pickups but the long line telephone circuits still present an obstacle.

LOS ANGELES VICTOR NOBLE

Judging by the recently reported paring down of Eastern technical staffs and the hiring of new men on the West Coast to replace them it appears the big chains are now "on top" of this situation, realizing that facilities must be split between the two Coasts.

Service Vs. Price

You have in the past expressed an interest in businesses outside your own country and it occurred to me that you might like to have a copy of our latest house magazine.

This publication is an effort to counteract the chain stores who, having exhausted

the possibilities of London and other large cities, are invading the provinces, and by means of absurd allowances on old sets, are making it difficult for the smaller dealer to maintain his turnover.

I believe your country has had a great deal to contend with in this connection, and I have noted of late that you have endeavored to lay down some kind of schedule for trade-ins. In this country we have strict maintenance of list prices, but unfortunately the undermining of these by large allowances for old sets has not been effectively dealt with.

Hence our only chance of survival is to shout Service with a big "S," as we do in words and pictures in the new booklet.

COLCHESTER, ENGLAND F. W. STRAW
F. W. Straw Radio, Ltd.

The pictures in your booklet showing your extremely complete service facilities certainly should sway many customers in your direction. Too bad space limitations prevent us from reproducing the book for our American readers.

We send you herewith a folder descriptive of our new location and the departments we maintain. Service departments, especially, are described and pictured.

KANSAS CITY, Mo. C. W. DONALDSON
Donaldson Radio and Electric Co., Inc.

Cincinnati Interested?

If available, send us 50 copies of the article in the November, 1936 issue titled: "Milwaukee Dealers Fight Industrial Discounts."

CINCINNATI W. J. WITTEKIND
*Chairman, Trades Relation Comm.,
Appliance Dealers Ass'n.*

Milwaukee is sending out a new series of letters designed to curb the practice referred to again this year. We've just seen copies.

Don't Know Our Strength

We have certainly been amazed at the flood of letters that have reached us since our article "Service Debt Collection Method" appeared on page 16 of September *Radio Retailing*.

Letters have come to us from forty-five states and two Canadian provinces. As many as seventeen have reached us in a single mail delivery. We had no idea that this article would create such a storm of interest.

We have had 500 extra delivery receipts printed in order to take care of this correspondence but it is a physical impossibility to answer all of these letters. If you think that sufficient interest has been aroused we will be glad to write an additional article answering some of the more important questions that have been asked. If not, will you

please insert a paragraph somewhere in your next issue and explain to your readers that our failure to answer their questions is not negligence on our part but would entail hiring extra personnel. At this time of the year this is impossible.

MACON, GA.

A. M. STANTON
Stanton Sound Service

Ok, shoot the sequel along and we'll publish it in an early issue.

We'll Try to Get It

As a subscriber to *Radio Retailing* for several years I am writing in reference to what seems an oversight in the technical pages. All types of receivers and many troubles are covered but I have yet to see any reference made to installation of either home type or auto type sets on yachts and fishing boats.

OAK BLUFFS, MASS.

W. P. HORNE
S & H Electric Co.

We have published a few items but the subject is not of universal interest and it's not often covered. We'll try to do a job on this before the boating season comes around.

We Bite, Who?

It is amazing to note in this enlightened age that the Civil Service Commission of so modern a city as New York gives to radio service technicians the title "Radio Repair Mechanic" and places them in the "labor" class. Public address operators, radio operators, broadcasting supervisors and radio engineers are placed in a classification known as Part 3, Engineering service, Group 4.

In contradistinction, the Civil Service examination requirements of radio service technicians are such as to attract only the most qualified men in this field.

Many campaigns have been conducted by leading groups of radio service technicians, manufacturers and technical periodicals to make the public cognizant of the proper status of those engaged in this field of endeavor. Who is to blame that public officials have not been correctly informed?

EDWARD T. BICAK
SPRINGFIELD GARDENS, N. Y.

Satisfied Subscriber Dept.

May I take this opportunity to compliment you on the high standard you are maintaining and express the pleasure and invaluable information I derive from this gold mine of facts and figures. *Radio Retailing* is the tops.

GEORGE E. LINGAFELTER
Ling's Radio Service
MANSFIELD, OHIO

ELECTRIC MOTOR



**PRESS
BUTTON
TUNING**

**BETTER-
COSTS LESS**

CROSLLEY PRESTOTUNE

As a smashing climax to the introduction of the greatest radio line in its history, Crosley presents these spectacular Prestotune Electric Press Button Tuning radio models. Combining as no other radio on the market does, such outstanding selling features as advanced electric tuning, smart cabinet styling by the world's foremost design authority, and sensationally low price—the Crosley Prestotune has met with instant dealer and customer acceptance, wherever shown. Until you have seen and heard these marvelous new radios you can never appreciate either their remarkable performance or amazing value. Have your Crosley Distributor demonstrate the new Prestotune for you today and put this sure-fire salesman on your floor now for the coming buying season.

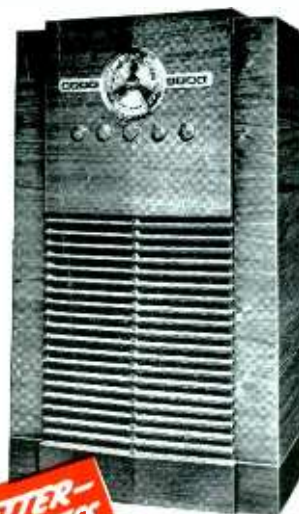

**BETTER-
COSTS LESS**

CROSLLEY PRESTOTUNE 11 CONSOLE

Press Button Tuning with 8 station controls. Adaptable for use with remote control. New type selector switch permits quick and easy adjustment. Large Mirro-Dial, 12" plug-in type speaker; 3 gang condenser. Variable selectivity; bass compensation on volume control. Receives American and Foreign broadcasts, 3 bands—535-1850 Kc.; 1900-6600 Kc.; and 6500-22,000 Kc. Attractive V-type front console of quarter stripe walnut, hand rubbed finish. Dimensions: 41½" high, 25½" wide, 12¾" deep.

\$109⁹⁵

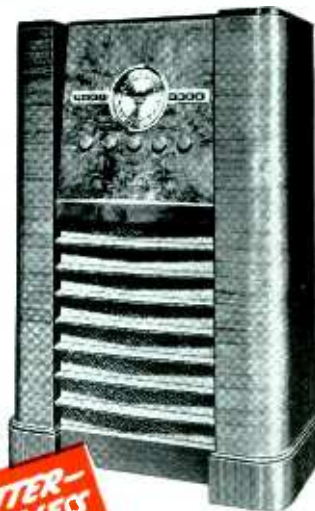

**BETTER-
COSTS LESS**

CROSLLEY PRESTOTUNE 12 CONSOLE

A marvelous 12-tube all-wave, Press Button Tuning radio in a massive modern cabinet. Receives American and Foreign broadcasts, 3 bands, 535-1725 Kc.; 2000-6800 Kc.; and 6000-22,000 Kc. Eight press buttons. Plug-in type adaptor for use with remote control. New type selector switch for use with press buttons, permitting quick and easy adjustment. Large gold reflector type Mirro-Dial. New type tone control; 3 gang condenser; I. F. variable selectivity. Bass compensation on volume control. Sloping panel cabinet of highly figured quarter stripe walnut. Pilasters and base of quarter stripe walnut. Dimensions: 43" high, 29¾" wide, 14½" deep.

\$137⁵⁰



**BETTER-
COSTS LESS**

CROSLLEY PRESTOTUNE 12 LOWBOY

A really magnificent cabinet housing a marvelous 12-tube radio with electric press button tuning. Receives American and Foreign broadcasts, 3 bands, all-wave. Recessed controls. 8 press buttons. Plug-in type adaptor available for use with remote control. New type selector switch. New continuously variable tone control. 12" electro-dynamic speaker of the plug-in type. 3 gang condenser. I. F. variable selectivity. Parallel Pentode output, 14 watts. Top, sides and front of the cabinet are mahogany with decorative maple inlays. Gold trim on base and grille. Hand rubbed finish. Dimensions: 30" high, 48" wide, 15½" deep.

\$159⁵⁰

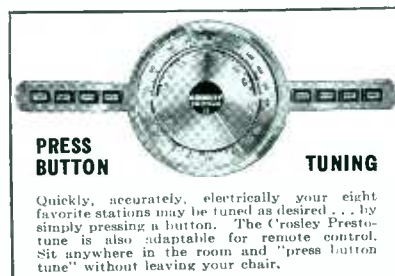

**PRESS
BUTTON**

TUNING

Quickly, accurately, electrically your eight favorite stations may be tuned as desired . . . by simply pressing a button. The Crosley Prestotune is also adaptable for remote control. Sit anywhere in the room and "press button tune" without leaving your chair.

(Prices slightly higher in South and West)

THE CROSLLEY RADIO CORPORATION - CINCINNATI POWEL CROSLLEY, Jr., President
Home of "the Nation's Station"—WLW—500,000 watts—70 on your dial.

YOU'RE THERE WITH A CROSLLEY

Radio's Two Biggest Selling Months Are Here



Make Them
the Biggest
In Your Business

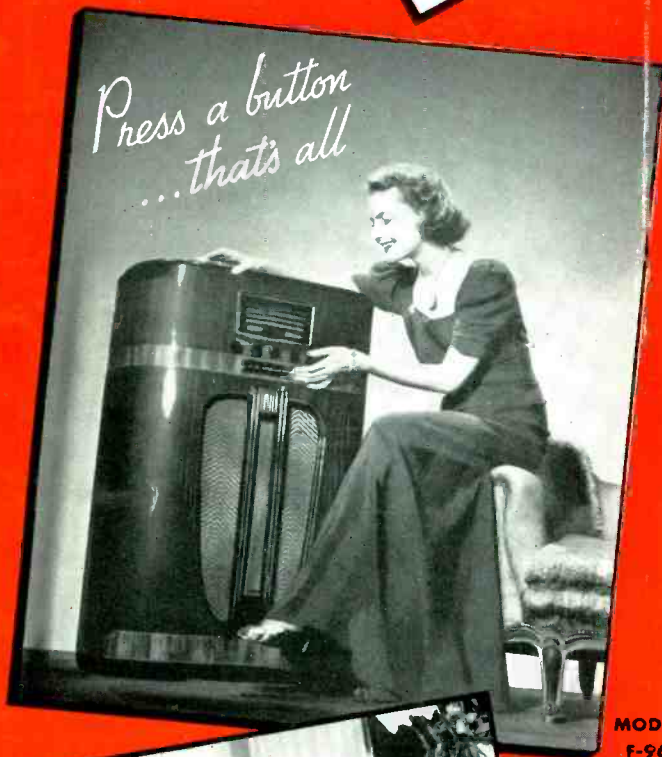

WITH THESE TWO SENSATIONAL GENERAL ELECTRIC TOUCH TUNING MODELS

MODEL
F-96

MODEL F-96

G-E touch tuning—just press a button that's all—at a sensational, low price. The biggest radio dollar value in years, with an exceptional appeal to all buyers. Stocks now being rushed to your G-E Radio Distributor for immediate delivery.

MODEL F-107

It's head and shoulders above other radios in the field. The highest development in automatic tuning. More stations at your finger tips—16 buttons in all. Exclusive G-E scan button—plus many other features. A real Christmas business promoter.



REMOTE
TOUCH TUNING
CONTROL

MODEL F-107

The
New
1938



GENERAL ELECTRIC
RADIO

APPLIANCE AND MERCHANDISE DEPARTMENT, GENERAL ELECTRIC COMPANY, BRIDGEPORT, CONN.